

▪BEMETA



kainoraštis2024

kainoraštis2024

PRICE LIST

BEMETA

ANOTACIJA

ANNOTATION



Naujas
New



Rinkinys 199352010 vonios reikmenims klijuoti nėra pridedamas prie aksesuarų.
Can be glued, set 199352010 for gluing bathroom accessories is not part of the package.



Produktas yra su lipnia juosta tvirtinimui, neprigrežiamas.
The product is provided with adhesive tape, no drill.



Išpardavimas, prekių kiekis ribotas.
Till sold out.



Komplektas vonios reikmenims klijuoti

Adhesive set for bathroom accessories

80×140×25 mm

199352010

10 €

Dangtelis tinka;

Usable for:

OBLA, STELLA, OMEGA, BETA, NEO,
WHITE, DARK, HEMATIT, GRAFIT, CORAL,
AMBER, BRILO, SABLO

TURINYS

CONTENT

OBLA ^N /STELLA ^N	2
CIRCUM ^N /QUADRA ^N	3
ORGANIC BLACK ^N	4 - 5
ORGANIC	6 - 7
GALLA	8
GAMMA	9 - 10
BRILO/SABLO	11
CORAL/AMBER	12
HEMATIT/GRAPHIT	13
OMEGA	14 - 20
WHITE/DARK	21 - 24
NEO	25 - 27
BETA	28 - 30
EASY/EASY01	31 - 33
NIVA	34
VIA	35 - 36
NERO	37 - 38
SOLO	39
ALFA/NOX	40
PLAZA	41
OVAL	42
TASI	43
NIKI	44
KERA	45
RETRO	46 - 48
VISTA	49
RAWELL	50
ELEKTRINIAI RANKŠLUOSČIŲ DŽIOVINTUVAI ^N	51
HEATED TOWEL RAILS	
CYTRO	52 - 55
KOSMETINIAI VEIDRODŽIAI IR VEIDRODŽIAI	56 - 60
COSMETIC MIRRORS AND MIRRORS	
VIEŠOSIOS ERDVĖS	61 - 74
PUBLIC SPACES	
VONIOS KAMBARIO PRIEDAI	75 - 77
SHOWER PROGRAM	
NERŪDIJANTIS PLIENAS	78 - 79
STAINLESS STEEL PRODUCT RANGE	
ATSARGINĖS DALYS	80 - 85
SPARE PARTS	
HELP	86 - 99
HELP PROGRAM	

Kainos galioja nuo 1. 6. 2024. Visos kainos nurodytos su PVM.

Prices with VAT are valid from 1. 6. 2024.

OBLA / STELLA

Galima klijuoti su vonios reikmenų klijavimo rinkiniu
Can be glued with a set for gluing bathroom accessories

165XXXXXX

166XXXXXX



Medžiaga
Material

cinko
zinc

stiklo
glass

Paviršiaus apdaila
Surface finish

Blizgus
Polished

Kabliukas
Single robe hook
54×54×72 mm

165206022
166206022

20 €
26 €

Kabliukas
Single robe hook
54×54×56 mm

165106062
166106062

15 €
20 €

WC popieriaus laikiklis su dangteliu
Toilet paper holder with cover
136×194×116 mm

165212012
166212012

48 €
53 €

WC popieriaus laikiklis be dangtelio
Toilet paper holder without cover
138×118×72 mm

165112222
166112222

40 €
45 €



WC popieriaus laikiklis be dangtelio
Toilet paper holder
178×54×72 mm

165212032
166212032

31 €
37 €

WC popieriaus laikiklis vertikalus
Spare toilet paper holder
54×158×72 mm

165112032
166112032

26 €
32 €

WC šepetėlio laikiklis stiklinis pakabinamas
Wall mounted toilet brush holder
110×360×145 mm

165113012
166113012

46 €
52 €

Stiklinė muilinė pakabinama
Soap dish
110×54×130 mm

165108042
166108042

34 €
40 €



Stiklinė su laikikliu pakabinama
Toothbrush holder
80×140×140 mm

165110012
166110012

34 €
40 €

Stiklinis muilo dozatorius pakabinamas
Soap dispenser
82×190×110 mm, 250 ml

165109017
166109017

72 €
77 €

Rankšluosčių laikiklis
Towel holder
654×54×214 mm

165205082
166205082

99 €
110 €

Trigubas kabliukas
Hanger with 3 hooks, swivel
54×193×135 mm

165206072
166206072

56 €
68 €



Rankšluosčių laikiklis
Towel holder
354×54×72 mm

165204012
166204012

41 €
52 €

Rankšluosčių laikiklis
Towel holder
654×54×72 mm

165204042
166204042

50 €
61 €

Dvigubas rankšluosčių laikiklis
Double towel holder
654×54×122 mm

165204052
166204052

68 €
80 €

Dvigubas rankšluosčių laikiklis
Double towel holder, swivel
54×163×416 mm

165204102
166204102

51 €
64 €



Žiedinė rankšluosčių pakaba
Ring towel holder
168×173×72 mm

165204062
166204062

31 €
37 €

Trigubas rankšluosčių laikiklis
Triple towel holder, swivel
54×193×416 mm

165204112
166204112

64 €
75 €

Lentynėlė rankšluosčiams
Towel holder with rail
654×107×214 mm

165205072
166205072

125 €
136 €

CIRCUM^N / QUADRA^N

Galima klijuoti su vonios reikmenų klijavimo rinkiniu ^NB
Can be glued with a set for gluing bathroom accessories

168XXXXXX

169XXXXXX



Kabliukas
Single robe hook
52×52×40 mm
168106062 8 €
169106062 8 €

Dvigubas kabliukas
Double robe hook
86×52×63 mm
168106032 13 €
169106032 13 €

WC popieriaus laikiklis su dangteliu
Toilet paper holder with cover
137×140×55 mm
168112012 23 €
169112012 24 €

WC popieriaus laikiklis be dangtelio
Toilet paper holder without cover
137×110×55 mm
168112042 21 €
169112042 22 €

Medžiaga
Material

cinko
zinc

stiklo
glass

Paviršiaus apdaila
Surface finish

Blizgus
Polished



WC popieriaus laikiklis be dangtelio, dešinė
Toilet paper holder, right
170×52×80 mm
168212032 18 €
169212032 19 €

WC popieriaus laikiklis be dangtelio, kairė
Toilet paper holder, left
170×52×80 mm
168212032L 18 €
169212032L 19 €

WC popieriaus laikiklis vertikalus
Spare toilet paper holder
52×170×80 mm
168112032 18 €
169112032 19 €



Stiklinė muilinė pakabinama
Soap dish
110×57×130 mm
168108042 16 €
169108042 17 €

Stiklinė su laikikliu pakabinama
Toothbrush holder
65×95×110 mm
168110012 16 €
169110012 16 €

Stiklinis muilo dozatorius pakabinamas
Soap dispenser
68×155×120 mm, 200 ml
168109017 24 €
169109017 25 €

WC šepetio laikiklis stiklinis pakabinamas
Wall mounted toilet brush holder
113×360×130 mm
168113012 20 €
169113012 21 €



Stiklinė lentynėlė
Glass shelf
520×52×136 mm
168102042 23 €
169102042 24 €

Rankšluosčių laikiklis
Towel holder
352×52×75 mm
168204012 25 €
169204012 27 €

Rankšluosčių laikiklis
Towel holder
502×52×75 mm
168204022 26 €
169204022 27 €

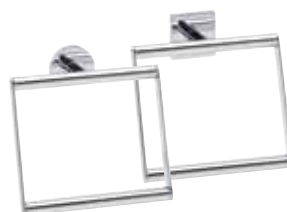

Rankšluosčių laikiklis
Towel holder
652×52×72 mm
168204042 27 €
169204042 28 €

Dvigubas rankšluosčių laikiklis
Double towel holder, swivel
52×52×420 mm
168204192 23 €
169204192 24 €

Žiedinė rankšluosčių pakaba
Ring towel holder
168×166×60 mm
168104062 25 €
169104062 26 €

Komplektas vonios reikmenims klijuoti Quadra, Circum
Adhesive set bathroom accessories Quadra, Circum
168×166×60 mm
199352012 8 €

organic BLACK

167106190



167106190L

Kabliukas
Single robe hook
44×58×39 mm
167106190 17 €
167106190L 17 €



Dvigubas kabliukas
Double robe hook
68×58×39 mm
167106210 19 €

167106200



167106200L

Asimetriškas kabliukas
Asymmetric robe hook
68×78×39 mm
167106200 19 €
167106200L 19 €



WC šepėčio laikiklis pakabinamas
Wall mounted toilet brushed
80×345×110 mm
167113060* 62 €



WC popieriaus laikiklis be dangtelio
Paper holder
150×40×59 mm
167112020 36 €



WC popieriaus laikiklis vertikalus
Spare toilet paper holder
38×165×59 mm
167112030 31 €



WC popieriaus laikiklis su dangteliu/mobilaus telefono lentynėle
Toilet paper holder with shelf
150×75×110 mm
167112150 43 €



Dvigubas WC popieriaus laikiklis su dangteliu/mobilaus telefono lentynėle
Double paper holder with shelf
280×75×110 mm
167112160 80 €



Dantų šepetėlių laikiklis
Toothbrush holder
100×100×110 mm, 200 ml
167111010 49 €



WC šepėčio laikiklis stiklinis pakabinamas
Wall mounted toilet brushed with glass dish
95×360×122 mm
167113140 54 €



Dvigubas muilo dozatorius pakabinamas
Double liquid soap dispenser
200×115×100 mm, 2×200 ml
167109270 152 €



Muilo dozatorius pakabinamas
Liquid soap dispenser
100×115×110 mm, 200 ml
167109260 78 €



Muilo dozatoriaus atidarytuvas
Soap dispenser opener
157132016
Dalis muilo dozatorių pakuotės.
Part of the packaging of soap dispensers.

* baltas šepėtyš/white brushed
** juodas šepėtyš/black brushed

**Metalinė muilinė**

Soap dish

120×25×85 mm

167108330

32 €

**Žiedinė rankšluosčių pakaba**

Ring towel holder

250×241×123 mm

167104390

114 €

**Žiedinė rankšluosčių pakaba**

Ring towel holder

250×110×59 mm

167104380

63 €

**Žiedinė rankšluosčių pakaba**

Ring towel holder

220×20×112 mm

167104060

43 €

**Rankšluosčių laikiklis**

Towel holder

455×38×59 mm

167104350

60 €

**Rankšluosčių laikiklis**

Towel holder

555×38×59 mm

167104360

66 €

**Rankšluosčių laikiklis**

Towel holder

655×38×59 mm

167104370

73 €

**Dvigubas rankšluosčių laikiklis**

Double towel holder

640×20×124 mm

167104050

82 €

**Dvigubas rankšluosčių laikiklis**

Double towel holder

500×20×112 mm

167104400

95 €

**Dvigubas rankšluosčių laikiklis**

Double towel holder, swivel

62×42×445 mm

167004100

88 €

**Lentynėlė rankšluosčiams**

Towel holder

640×20×214 mm

167105080

121 €

**Lentynėlė rankšluosčiams**

Towel holder with rail

640×95×214 mm

167105150

142 €

**Metalinė lentynėlė**

Metal shelf

300×22×110 mm

167102370

88 €

**Metalinė lentynėlė**

Metal shelf

600×22×110 mm

167102380

127 €

**Stiklinė lentynėlė**

Glas shelf

600×40×115 mm

167102240

60 €

ORGANIC

Design by doc. MgA. René Šulc

Medžiaga
Material

nerūdijantis
plienas
stainless
steel

stiklo
glass

plastmasinis
plastic

Paviršiaus apdaila
Surface finish

chromas
chrome

Blizgus
Polished



Kabliukas
Single robe hook
44×58×39 mm
157106191 15 €
157106191L 15 €



Dvigubas kabliukas
Double robe hook
68×58×39 mm
157106211 15 €



Asimetriškas kabliukas
Asymmetric robe hook
68×78×39 mm
157106201 16 €
157106201L 16 €



WC šepėčio laikiklis pakabinamas
Wall mounted toilet brush holder brushed
80×345×110 mm
157113061 55 €



WC popieriaus laikiklis be dangtelio
Paper holder
150×40×59 mm
157112021 33 €



WC popieriaus laikiklis vertikalus
Spare toilet paper holder
38×165×59 mm
157112031 30 €



WC popieriaus laikiklis su dangteliu/mobiliaus telefono lentynėle
Toilet paper holder with shelf
150×75×110 mm
157112151 38 €



Dvigubas WC popieriaus laikiklis su dangteliu/mobiliaus telefono lentynėle
Double paper holder with shelf
280×75×110 mm
157112161 68 €



Dantų šepetėlių laikiklis
Toothbrush holder
100×100×110 mm, 200 ml
157111011 36 €



WC šepėčio laikiklis stiklinis pakabinamas
Wall mounted toilet brush holder brushed with glass dish
95×360×122 mm
157113141 50 €



Dvigubas muilo dozatorius pakabinamas
Double liquid soap dispenser
200×115×100 mm, 2×200 ml
157109271 120 €



Muilo dozatorius pakabinamas
Liquid soap dispenser
100×115×110 mm, 200 ml
157109261 60 €



Muilo dozatoriaus atidarytuvas
Soap dispenser opener
157132016
Dalis muilo dozatorių pakuotės.
Part of the packaging of soap dispensers.

* baltas šepetys/white brushed
** juodas šepetys/black brushed

**Metalinis muilo indas**

Soap dish

120×25×85 mm

157108331

28 €

**Žiedinė rankšluosčių pakaba**

Ring towel holder

250×241×123 mm

157104391

108 €

**Žiedinė rankšluosčių pakaba**

Ring towel holder

250×110×59 mm

157104381

57 €

**Žiedinė rankšluosčių pakaba**

Ring towel holder

220×20×112 mm

157104061

40 €

**Rankšluosčių laikiklis**

Towel holder

455×38×59 mm

157104351

54 €

**Rankšluosčių laikiklis**

Towel holder

555×38×59 mm

157104361

60 €

**Rankšluosčių laikiklis**

Towel holder

640×38×59 mm

157104371

66 €

**Dvigubas rankšluosčių laikiklis**

Double towel holder

640×20×124 mm

157104051

60 €

**Dvigubas rankšluosčių laikiklis**

Double towel holder

500×20×112 mm

157104401

80 €

**Dvigubas rankšluosčių laikiklis**

Double towel holder, swivel

62×42×445 mm

157004101

70 €

**Lentynėlė rankšluosčiams**

Towel holder

640×20×214 mm

157105081

107 €

**Lentynėlė rankšluosčiams**

Towel holder with rail

640×95×214 mm

157105151

119 €

**Metalinė lentynėlė**

Metal shelf

300×22×110 mm

157102371

85 €

**Metalinė lentynėlė**

Metal shelf

600×22×110 mm

157102381

115 €

**Stiklinė lentynėlė**

Glas shelf

600×40×115 mm

157102241

60 €

GALLA

Medžiaga
Material

žalvaris
brass

nerūdijantis
plienas
stainless
steel

poliruotas
juoda
polished
black

Paviršiaus apdaila
Surface finish

PVD

Blizgus
Polished

Mattinis
Matt



Kabliukas
Single robe hook
20×60×46 mm
108106020

22 €



**WC popieriaus laikiklis
be dangtelio**
Paper holder without cover
155×30×60 mm
108112030

36 €



Muilinė pakabinama
Soap dish
107×34×115 mm
108108020

48 €



**Dantų šepetėlių laikiklis
pakabinamas**
Toothbrush holder
75×123×99 mm
108110010

49 €



**Dvigubas dantų šepetėlių
laikiklis pakabinamas**
Double Toothbrush holder
170×123×79 mm
108110020

74 €



**WC šepetėlio laikiklis
pakabinamas**
Toilet brush holder
105×360×119 mm
108113010*

80 €



**Muilo dozatorius
pakabinamas**
Soap dispenser
75×170×99 mm, 230 ml
108109010

74 €



Žiedinė rankšluosčių pakaba
Ring towel holder
230×100×60 mm
108104060

45 €



Rankšluosčių laikiklis
Towel holder
600×20×60 mm
108104040

68 €



Dvigubas rankšluosčių laikiklis
Double towel holder
600×20×104 mm
108104050

99 €



Lentynėlė rankšluosčiams
Towel holder
600×20×200 mm
108105080

160 €

* juodas šepetys/black brushed

GAMMA



Kabliukas
Single robe hook
15×42×43 mm
145804022

26 €



WC popieriaus laikiklis be dangtelio
Toilet paper holder without cover
128×98×50 mm
145812022

56 €



WC popieriaus laikiklis su dangteliu
Toilet paper holder with cover
128×135×50 mm
145812012

69 €



WC popieriaus laikiklis be dangtelio
Toilet paper holder
180×36×65 mm
145812222

41 €

Medžiaga
Material

nerūdijantis plienas
stainless steel

polirezinas juoda
polyresin black

polirezinas baltas
polyresin white

Paviršius apdaila
Surface finish

chromas
chrome



Blizgus
Polished



Muilinė
Soap dish
105×45×95 mm
145408312 juodas/black
145508312 baltas/white

62 €

62 €

Stiklinė su laikikliu pakabinama
Toothbrush holder
115×115×95 mm
145411012 juodas/black
145511012 baltas/white

62 €

62 €



WC šepetėlio laikiklis pakabinamas
Toilet brush holder
125×386×105 mm
145413092 juodas/black
145513092 baltas/white

120 €

120 €

Muilo dozatorius pakabinamas
Soap dispenser
115×160×95 mm, 200 ml
145409012 juodas/black
145509012 baltas/white

90 €

90 €



Muilinė pastatoma
Soap dish free standing
95×15×95 mm
145608310 juodas/black
145708314 baltas/white

16 €

16 €

Dantų šepetėlių laikiklis pastatomas
Toothbrush holder free standing
75×115×75 mm
145611310 juodas/black
145711314 baltas/white

19 €

19 €

WC šepetėlio laikiklis pastatomas
Toilet brush holder free standing
92×385×92 mm
145613310 juodas/black
145713314 baltas/white

50 €

50 €





Muilo dozatorius pastatomas

Soap dispenser free standing,

75×160×86 mm, 200 ml

145609310 juodas/black

45 €

145709314 baltas/white

45 €



Muilinė pastatoma

Round soap dish free standing

110×25×110 mm

145608320 juodas/black

16 €

145708324 baltas/white

16 €



Dantų šepetėlių laikiklis pastatomas

Toothbrush holder free standing

72×120×72 mm

145611320 juodas/black

17 €

145711324 baltas/white

17 €



WC šepėčio laikiklis pastatomas

Round toilet brush holder free standing

98×455×98 mm

145613320 juodas/black

45 €

145713324 baltas/white

45 €



Muilo dozatorius pastatomas

Round soap dispenser free standing

72×175×86 mm, 250 ml

145609320 juodas/black

25 €

145709324 baltas/white

25 €



Rankšluosčių laikiklis

Towel holder

300×36×75 mm

145804012

59 €



Rankšluosčių laikiklis

Towel holder

600×36×75 mm

145804042

82 €



Dvigubas atlenkiamas rankšluosčių laikiklis

Double towel holder, swivel

40×55×420 mm

145804102

98 €



Stiklinė lentynėlė

Glass shelf

600×36×100 mm

145802312

111 €

BRILO / SABLO

161XXXXXX

160XXXXXX

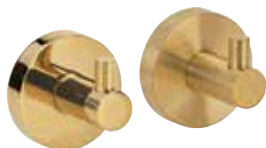

Kabliukas
Single robe hook
55×55×50 mm
161106020 26 €
160106020 26 €



Dvigubas kabliukas
Double robe hook
55×55×50 mm
161106032 27 €
160106032 27 €



Kabliukas
Single robe hook
16×16×30 mm
161506090 7 €
160506090 7 €



WC popieriaus laikiklis be dangtelio
Toilet paper holder without cover
140×95×90 mm
161112042 48 €
160112042 53 €

Medžiaga
Material

žalvaris
brass

stiklo
glass

Paviršiaus apdaila
Surface finish

PVD

Blizgus
Polished

Matinis
Matt

Matinis
Matt



WC popieriaus laikiklis su dangteliu
Toilet paper holder with cover
140×155×80 mm
161112010 67 €
160112010 65 €



WC popieriaus laikiklis be dangtelio
Toilet paper holder
175×55×70 mm
161212030 53 €
160212030 53 €



WC popieriaus laikiklis vertikalus
Spare toilet paper holder
55×165×65 mm
161112030 40 €
160112030 41 €



WC šepėčio laikiklis stiklinis pakabinamas
Toilet brushed
95×370×140 mm
161113017* 74 €
160113017* 64 €



WC šepėčio laikiklis pastatomas/pakabinamas
Toilet brush holder free standing/hanging
95×380×105 mm
161313060* 106 €
160313060* 109 €



Stiklinė muilinė pakabinama
Soap dish
110×55×129 mm
161108042 48 €
160108042 53 €



Stiklinė su laikikliu pakabinama
Toothbrush holder
70×95×105 mm
161110012 47 €
160110012 48 €



Stiklinis muilo dozatorius pakabinamas
Soap dispenser
75×145×100 mm
161109102 72 €
160109102 71 €



Vonios rankena
Grab bar
350×50×75 mm
161307611 80 €
160307611 73 €



Muilinė kampinė
Corner shower shelf
250×60×155 mm
161208340 96 €
160208340 103 €



Rankšluosčių laikiklis
Towel holder
505×55×65 mm
161204020 64 €
160204020 61 €



Rankšluosčių laikiklis
Towel holder
655×55×65 mm
161204042 68 €
160204042 73 €



Dvigubas rankšluosčių laikiklis
Towel holder
655×55×110 mm
161204052 102 €
160204052 109 €



Dvigubas rankšluosčių laikiklis
Double towel holder, swivel
55×55×420 mm
161204190 73 €
160204190 79 €



Šiukšliadėžė su lėtai užsidarančiu dangčiu
Waste bin
205×260×205 mm, 5 l
161315010 84 €
160315010 84 €

??
The color shade of the trashbasket may differ from the image in the photo.

* juodas šepetys/black brushed

coral / amber

158XXXXXX

155XXXXXX



Medžiaga
Material

zavaris
brass

stiklo
glass

Paviršiaus apdaila
Surface finish

PVD



Blizgus
Polished



Matinis
Matt

Kabliukas
Single robe hook
55×55×50 mm

158106022
155106022

29 €
29 €

Dvigubas kabliukas
Double robe hook
55×55×50 mm

158106032
155106032

29 €
29 €

WC popieriaus laikiklis su dangteliu
Toilet paper holder with cover
140×155×80 mm

158112012
155112012

77 €
77 €



WC popieriaus laikiklis be dangteliu
Toilet paper holder
55×165×65 mm

158212032
155212032

43 €
53 €

WC popieriaus laikiklis vertikalus
Spare toilet paper holder
55×165×65 mm

158112032
155112032

47 €
47 €



WC šepetėlio laikiklis stiklinis pakabinamas
Toilet brushed
95×360×140 mm

158113017*
155113017*

74 €
74 €

WC šepetėlio laikiklis pastatomas/pakabinamas
Toilet brush holder free standing/hanging
95×380×105 mm

158313067*
155313067*

124 €
123 €



Stiklinė muilinė pakabinama
Soap dish
110×55×129 mm

158108042
155108042

52 €
53 €



Stiklinė su laikikliu pakabinama
Toothbrush holder
70×95×105 mm

158110012
155110012

52 €
53 €



Stiklinis muilo dozatorius pakabinamas
75×145×100 mm, 200 ml

158109102
155109102

80 €
85 €



Rankšluosčių laikiklis
Towel holder
505×55×65 mm

158204022
155204022

70 €
70 €



Rankšluosčių laikiklis
Towel holder
655×55×65 mm

158204042
155204042

83 €
83 €



Muilinė kampinė
Corner shower shelf
265×90×205 mm

158208312
155208312

75 €
84 €



Šiukšliadėžė su lėtai užsidarančiu dangčiu
Waste bin
205×260×205 mm, 5 l

158315010
155315010

Šiukšliadėžė su lėtai užsidarančiu dangčiu
Waste bin
205×260×205 mm, 5 l

158315010
155315010

84 €
84 €

The color shade of the trashbasket may differ from the image in the photo.
Der Farbton des Mülleimers kann von der Abbildung auf dem Foto abweichen.

! Išpardavimas, prekių kiekis ribotas./Till sold out.
• KITOKIS ATspalvis/A DIFFERENT SHADE

HEMATIT / GRAPHIT

159XXXXXX

156XXXXXX



Kabliukas
Single robe hook
55×55×50 mm
159106022
156106022

31 €
31 €



Dvigubas kabliukas
Double robe hook
55×55×50 mm
159106032
156106032

31 €
31 €



WC popieriaus laikiklis be dangtelio
Toilet paper holder without cover
140×95×90 mm
156112042

53 €
53 €



WC popieriaus laikiklis su dangteliu
Paper holder with cover
140×155×80 mm
159112012
156112012

83 €
81 €

Medžiaga
Material

žalvaris
brass

stiklo
glass

Paviršiaus apdaila
Surface finish

PVD

Blizgus
Polished

Matinis
Matt



Kabliukas
Single robe hook
16×16×30 mm
156506092

7 €



WC popieriaus laikiklis be dangtelio
Paper holder without cover
175×55×70 mm
159212032
156212032

53 €
53 €



WC popieriaus laikiklis vertikalus
Spare toilet paper holder
55×165×65 mm
159112032
156112032

51 €
51 €



WC šepetėlio laikiklis stiklinis pakabinamas
Wall mounted toilet brush with glass dish
95×360×140 mm
159113017*
156113017*

82 €
82 €

WC šepetėlio laikiklis pastatomas/pakabinamas
Toilet brush holder free standing or hanging
95×342×105 mm
159313067*
156313067*

140 €
140 €



Stiklinė muilinė pakabinama
Glass soap dish
110×55×129 mm
159108042
156108042

58 €
58 €



Stiklinė su laikikliu pakabinama
Toothbrush holder
70×95×105 mm
159110012
156110012

58 €
58 €



Stiklinis muilo dozatorius MINI pakabinamas
Soap dispenser, MINI glass
75×145×100 mm, 200 ml
159109102
156109102

80 €
85 €

Rankšluosčių laikiklis
Towel holder
505×55×65 mm
159204022
156204022

78 €
78 €

Rankšluosčių laikiklis
Towel holder
655×55×65 mm
159204042
156204042

91 €
91 €

Muilinė kampinė
Soap dish
265×90×205 mm
159208312
156208312

75 €
84 €



Lentynėlė
Shelf
270×40×110 mm

156102272

99 €



Šiukšliadėžė su lėtai užsidarančiu dangčiu
Waste bin "Soft Close"
205×260×205 mm, 5 l
159315013
156315013

84 €
84 €



Šiukšliadėžė su lėtai užsidarančiu dangčiu
Waste bin "Soft Close"
205×260×205 mm, 5 l
159315013
156315013

84 €
84 €

The color shade of the trashbasket may differ from the image in the photo.
Der Farbton des Mülleimers kann von der Abbildung auf dem Foto abweichen.

** juodas šepetys/black brushed

! Išpardavimas, prekių kiekis ribotas./Till sold out.
• KITOKIS ATspalvis/A DIFFERENT SHADE

OMEGA

Medžiaga
Material

zavaris
brass

stiklo
glass

Paviršius apdaila
Surface finish

chromas
chrome

Blizgus
Polished



Kabliukas
Single robe hook
55×55×50 mm
104106022

14 €



Dvigubas kabliukas
Double robe hook
55×55×50 mm
104106032

16 €



Kabliukas
Single robe hook
55×55×70 mm
104206022

18 €



Dvigubas kabliukas
Double robe hook
84×60×66 mm
104206032

20 €

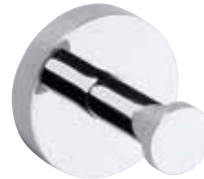

Kabliukas
Single robe hook
55×55×55 mm
104106062

12 €



Kabliukas
Single robe hook
25×25×38 mm
104206132

7 €

OMEGA RINKINYS, 6 vnt
SET OMEGA, 6 pcs
204601

117 €



Kabliukas priklijuojamas
Hook stick
51×51×41 mm
104206272

8 €



Kabliukas priklijuojamas
Hook stick
51×51×42 mm
104206262

9 €



Kabliukas
Single robe hook
ø 16×30 mm
104506092
ø 16×55 mm
104506082

6 €
7 €



Kabliukas (2 vnt)
Single robe hook, pair
ø 16×30 mm
104506292

10 €



Kabliukas
Single robe hook
ø 15×35 mm
104206023
ø 25×50 mm
104206024

5 €
6 €



Kabliukas (2 vnt)
Single robe hook, pair
ø 16×30 mm
104506282

12 €



Kabliukas
Cloth hook
55×110×60 mm
104105242

23 €



Kabliukas
Cloth hook
55×115×60 mm
104105252

25 €



WC popieriaus laikiklis be dangteliu
Paper holder without cover
140×95×90 mm
104112042
104112042R

25 €
25 €



WC popieriaus laikiklis su dangteliu
Paper holder with cover
140×155×80 mm
104112012
104112012R

38 €
38 €



WC popieriaus laikiklis su dangteliu
Paper holder with cover
135×170×90 mm
104212012

42 €



WC popieriaus laikiklis be dangteliu
Paper holder without cover
170×55×70 mm
104212032
104212032L

30 €



Dvigubas WC popieriaus laikiklis

Double paper holder
385×55×85 mm
104201072

50 €



Dvigubas WC popieriaus laikiklis su dangteliais

Double paper holder with cover
270×140×107 mm
104112092

75 €



WC popieriaus laikiklis be dangtelio

Paper holder without cover
150×105×67 mm
199112042

35 €



WC popieriaus laikiklis vertikalus

Spare toilet paper holder
55×165×65 mm
104112032

24 €



WC popieriaus laikiklis vertikalus, prailgintas

Spare toilet paper holder, extended
55×315×65 mm
104112142

32 €



WC šepėčio laikiklis pakabinamas

Wall mounted toilet brushed
95×385×120 mm
104913112*
104913117**

50 €



Pastatomas laikiklis WC šepėčiui ir popieriui

Free standing toilet paper and brushed holder
250×730×250 mm
104836012

3 927 €



Pastatomas laikiklis WC šepėčiui ir popieriui

Free standing toilet paper
250×730×250 mm
104836112

206 €



WC šepėčio laikiklis pakabinamas

Wall mounted toilet brushed
90×385×90 mm
104913122

43 €



WC šepėčio laikiklis pastatomas

Free standing toilet brush holder
90×385×90 mm
104913092

45 €



WC šepėčio laikiklis pastatomas

Free standing toilet brush holder
90×365×90 mm
104913152

35 €



WC šepėčio laikiklis stiklinis pastatomas

Toilet brush holder, for standing
110×400×130 mm
104113102*
104113107**

32 €
32 €



WC šepėčio laikiklis stiklinis pakabinamas

Wall mounted toilet brushed with glass dish
95×370×140 mm
104113012*
104113017**

41 €
41 €



WC šepėčio laikiklis pastatomas/pakabinamas

Toilet brush holder, free standing or hanging
95×380×105 mm
102313066*
102313067**

58 €
58 €



WC šepėčio laikiklis pakabinamas

Toilet brush holder, free standing
95×380×95 mm
102313056*
102313057**

58 €
58 €



Stiklinis muilo dozatorius pakabinamas

Soap dispenser, glass
85×114×100 mm, 200 ml
104309322

67 €



Stiklinis muilo dozatorius MINI pakabinamas

Soap dispenser MINI with glass
75×145×100 mm, 200 ml
104109102

47 €



Stiklinis muilo dozatorius pakabinamas

Soap dispenser
80×190×133 mm, 230 ml
104109017

55 €



Muilo dozatorius pakabinamas

Soap dispenser
55×175×85 mm, 150 ml
104109012

50 €



Muilo dozatorius pakabinamas

Soap dispenser
55×195×85 mm, 150 ml
104609172

58 €

* baltas šepetys/white brushed
** juodas šepetys/black brushed



Muilo dozatorius JUMBO pakabinamas

Soap dispenser
70×230×110 mm, 550 ml
104109032

114 €



Stiklinis pakabinamas muilo dozatorius su magnetu muilui

Soap dispenser with magnetic soap holder, glass
75×160×100 mm, 200 ml
104109182

69 €



Stiklinis muilo dozatorius MINI pakabinamas

Soap dispenser, MINI glass
75×150×100 mm, 200 ml
138709041

45 €



Stiklinė muilinė pakabinama

Soap dish
110×55×129 mm
104108042

30 €



Muilinė stačiakampė pakabinama

Soap dish
125×55×115 mm
104208082

25 €



Muilinė pakabinama

Soap dish
140×55×125 mm
104108162

28 €



Laikiklis-magnetas muilui

Magnetic soap holder
55×55×70 mm
104108202

26 €



Stiklinė su laikikliu pakabinama

Toothbrush holder
70×95×105 mm
104110012

28 €



Dantų šepetėlių laikiklis su 2 stiklinėmis pakabinamas

Double toothbrush holder
160×95×90 mm
104110022

43 €



Dantų šepetėlių laikiklis su 2 stiklinėmis pakabinamas

Toothbrushed Toothbrush holder
190×95×125 mm
104110042

55 €



Dantų šepetėlių laikiklis pakabinamas

Toothbrush holder
105×55×85 mm
104110032

24 €



Muilo dozatorius pastatomas

Soap dispenser free standing
80×160×80 mm, 200 ml
138109161

45 €



Stiklinė su laikikliu pastatoma

Glass Toothbrush holder free standing
80×100×80 mm
138110061

26 €



Stiklinė muilinė pastatoma

Soap dish free standing
110×60×110 mm
138108191

25 €



Trigubas kabliukas

Hanger with 3 hooks, swivel
55×190×135 mm
104206072

40 €



Trigubas kabliukas

Hanger with 3 hooks, swivel
55×85×95 mm
104106072

36 €



Dvigubas kabliukas

Double hook
55×120×90 mm
104405222

35 €



Lentynėlė

Shelf
270×40×110 mm
146102272

68 €



Pakaba su 4 kabliukais

Rail with 4 robe hooks
270×25×40 mm
104606102

29 €



Pakaba su 6 kabliukais

Rail with 6 robe hooks
410×25×40 mm
104606112

40 €



Pakaba su 2 kabliukais

Double hook
120×55×50 mm
104405202

27 €



Pakaba su 3 kabliukais

Hanger with 3 hooks, swivel
185×55×50 mm
104405232

40 €



Pakaba su 4 kabliukais

4 robe hooks
250×55×50 mm
104405212

55 €



Pakaba su 5 kabliukais

Hanger with 5 hooks
415×55×70 mm
104105112

40 €



Virtuvinio rankšluosčio laikiklis

Kitchen roll holder
295×100×62 mm
146403152

35 €



Dvigubas rankšluosčių laikiklis

Double towel holder
50×90×365 mm
104704142

33 €



Muilo dozatorius su laikikliu rankšluosčiui

Kitchen roll and soap dispenser holder
455×180×115 mm, 230 ml
104019012

84 €



Žiedinė rankšluosčių pakaba

Ring towel holder
160×175×65 mm
104204062

29 €



Žiedinė rankšluosčių pakaba

Ring towel holder
160×190×55 mm
104104062

25 €



Dvigubas rankšluosčių laikiklis

Double towel holder, swivel
55×165×450 mm
104204102

44 €



Trigubas rankšluosčių laikiklis

Triple towel holder swiveling
55×195×450 mm
104204112

60 €



Rankšluosčių laikiklis

Towel holder
355×55×65 mm
104104012
505×55×65 mm
104104022
655×55×65 mm
104104042

28 €

34 €

38 €



Dvigubas rankšluosčių laikiklis

Double towel holder
655×55×110 mm
104104052

45 €



Trigubas pastatomas rankšluosčių laikiklis

Free standing 3 swing arm towel stand
370×850×250 mm
104836032

185 €



Dvigubas rankšluosčių laikiklis

Double towel holder, swivel

55×55×420 mm

104204191

50 €



Lentynėlė rankšluosčiams

Towel holder

655×55×200 mm

104105082

65 €



Lentynėlė rankšluosčiams

Towel holder with rail

655×110×200 mm

104105072

75 €

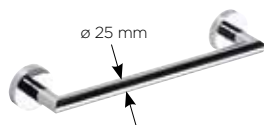

Rankšluosčių laikiklis

Towel holder

354×54×65 mm

104204332

653×54×65 mm

104204342

44 €



Rankšluosčių laikiklis, tvirtinamas prie stiklo

Towel holder for glass door

520×20×133 mm

104204352

68 €



Rankšluosčių laikiklis

Towel holder

355×55×65 mm

104204012

505×55×65 mm

104204022

655×55×65 mm

104204042

855×55×65 mm

104204262

35 €

40 €

48 €

54 €



Dvigubas rankšluosčių laikiklis

Double towel holder

655×55×120 mm

104204052

855×55×120 mm

104204272

60 €

Lentynėlė rankšluosčiams

Towel holder

655×55×215 mm

104205082

75 €



Atlenkiama lentynėlė rankšluosčiams

Tiltable Towel holder

655×55×270 mm

104205152

112 €



Lentynėlė rankšluosčiams

Towel holder with rail

655×110×215 mm

104205072

550×120×265 mm

104219072

108 €

Atlenkiama lentynėlė rankšluosčiams

Tiltable Towel holder with hooks

655×105×270 mm

104205162

125 €



Dviguba lentynėlė rankšluosčiams

Double Towel holder with rail

655×160×225 mm

104205102

130 €



U formos lentynėlė rankšluosčiams

"U" type double Towel holder

655×155×270 mm

104205172

135 €

Stiklinė lentynėlė

Glass shelf

300×55×130 mm

104122042

34 €

Stiklinė lentynėlė

Glass shelf

600×55×130 mm

104102042

37 €

**Stiklinė lentynėlė**

Glass shelf
600×65×130 mm
104202042

45 €

**Stiklinė lentynėlė**

Glass shelf with rail
300×55×130 mm
104102202

55 €

**Stiklinė lentynėlė**

Glass shelf with rail
600×55×130 mm
104102212

64 €

**Triguba stiklinė lentynėlė**

Triple glass shelf
400×665×130 mm
104202132

138 €

**Kampinė stiklinė lentynėlė**

Glass shelf corner model
325×55×255 mm
104102012

39 €

**Kampinė stiklinė lentynėlė**

Glass shelf with rail corner model
325×60×255 mm
104202162

50 €

**Dviguba stiklinė lentynėlė**

Double glass shelf
400×380×120 mm
104202122

109 €

**Dviguba stiklinė kampinė lentynėlė**

Double corner glass shelf
355×380×270 mm
104202142

100 €

**Triguba stiklinė kampinė lentynėlė**

Triple corner glass shelf
355×660×270 mm
104202152

135 €

**Vonios rankena**

Grab bar
355×55×75 mm
102307012
500×55×75 mm
102307052

40 €

41 €

**Kampinė vonios rankena**

Grab bar angled
460×250×80 mm
102307022

64 €

**Kampinė vonios rankena su muiline**

Grab bar angled with Soap dish
400×200×130 mm
102307032

75 €

**Vonios rankena**

Grab bar
350×50×75 mm
104307611

52 €

**Kampinė vonios rankena**

Grab bar angled
412×203×74 mm
104307621

65 €

**Kampinė vonios rankena su muiline**

Grab bar angled with Soap dish
440×220×130 mm
104307631

85 €



Rankena, su guma

Grab bar, rubber
355×50×80 mm
104507661

40 €



Rankena, su guma

Grab bar, rubber
455×50×85 mm
104507675

44 €



Rankena, su guma

Grab bar, rubber
655×50×80 mm
104507681

53 €



Rankena, su guma

Grab bar, rubber
855×50×80 mm
104507691

23 €

! Išpardavimas, prekių kiekis ribotas.
• Till sold out.



104507731
kairė/left

104507721
dešinė/right



Rankena kampu 90°, su guma

Grab bar 90°, rubber
420×420×80 mm
104507731
104507721

23 €

! Išpardavimas, prekių kiekis ribotas.
• Till sold out.

104507701
kairė/left



104507711
dešinė/right

Rankena kampu 135°, su guma

135° grab bar, black rubber
717×325×80 mm
104507711
104507701

80 €



Vatos diskelių dozatorius

Cosmetic pad dispenser
65×205×115 mm
146503172

35 €



Plaukų džiovintuvo laikiklis

Hairdryer holder, spiral
100×130×125 mm
104117022

30 €



Plaukų džiovintuvo laikiklis

Hairdryer holder
80×55×100 mm
101117012

27 €



Lentynėlės laikikliai (pora)

Glass shelf holder without glass, pair
19×19×28 mm

104502112-6mm ≠ 6 mm

104502112-8mm ≠ 8 mm

22 €

55×55×40 mm

104102112-6mm ≠ 6 mm

104102112-8mm ≠ 8 mm

30 €



Vatos diskelių dozatorius

Shower door wiper
265×175×55 mm
104237012

44 €



Kabliukas

Robe hook, polished finish
20×70×40 mm
104106152

30 €



Sukiojami veidrodžio laikikliai

Tilttable mirror holders
55×78×90 mm, ≠ 6 mm
301501131

44 €



Kabliukas priklijuojamas prie stiklo

Back plate for gluing accessories on glass***
55×55×14 mm
131567152

20 €

WHITE / DARK

XXXXXXXXX4

XXXXXXXXX0



Kabliukas
Single robe hook
55×55×50 mm
104106024
104106020

16 €
18 €

Dvigubas kabliukas
Double robe hook
55×55×50 mm
104106034
104106030

18 €
20 €

Kabliukas
Single robe hook
55×55×65 mm
104206020

23 €

WHITE/DARK RINKINYS, 6 vnt
Set WHITE/DARK, 6 pcs
55×55×50 mm
204604
204600

119 €
119 €



Kabliukas
Single robe hook
55×55×65 mm
104106060

16 €

Kabliukas
Single robe hook
16×16×30 mm
104506094
104506090

5 €
5 €

Kabliukas
Single robe hook
16×16×55 mm
104506080

9 €

Pakaba su 2 kabliukais
Double hook
120×55×50 mm
104405200

25 €

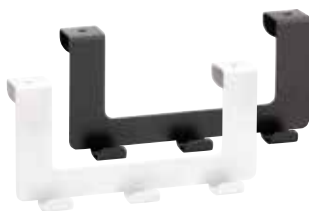

Kabliukas tvirtinamas ant durų
Hook for door
25×85×34 mm
101106154
101106150

6 €
6 €

Pakaba tvirtinama ant durų, su 3 kabliukais
Hanger for door, 3 hooks
175×87×34 mm
101106224
101106220

10 €
10 €

Pakaba tvirtinama ant durų, su 6 kabliukais
Hanger for door, 6 hooks
350×87×34 mm
101106234
101106230

15 €
15 €



Trigubas kabliukas
Swing arm Hanger with 3 hooks, swivel
55×190×135 mm
104206070

40 €

Pakaba su 4 kabliukais
Hanger with 4 hooks
270×25×40 mm
104606100

38 €

WC popieriaus laikiklis be dangtelio
Paper holder without cover
140×95×90 mm
104112044
104112040

26 €
27 €

WC popieriaus laikiklis su dangteliu
Paper holder with cover
140×155×80 mm
104112014
104112010

41 €
48 €



WC popieriaus laikiklis be dangtelio
Paper holder
175×55×70 mm
104212034
104212030

24 €
36 €

WC popieriaus laikiklis be dangtelio
Paper holder
175×55×70 mm
104212034L
104212030L

24 €
36 €

WC popieriaus laikiklis vertikalus
Spare toilet paper holder
55×165×65 mm
104112034
104112030

29 €
31 €

Dvigubas WC popieriaus laikiklis
Double paper holder
385×55×85 mm
104201070

52 €

Medžiaga
Material

žalvaris
brass

stiklo
glass

Paviršiaus apdaila
Surface finish

baltas
lakas
white
lacquer

juodas
lakas
black
lacquer

Matinis
Matt



WC šepėčio laikiklis stiklinis pakabinamas

Wall mounted toilet brushed with glass dish

95×370×140 mm

104113014

48 €



WC šepėčio laikiklis stiklinis pakabinamas

Wall mounted toilet brushed with glass dish

95×370×140 mm

104113010

48 €



WC šepėčio laikiklis pastatomas

Free standing toilet brush holder

90×385×90 mm

104913094

48 €



WC šepėčio laikiklis pastatomas

Free standing toilet brush holder

90×380×90 mm

104913090

50 €

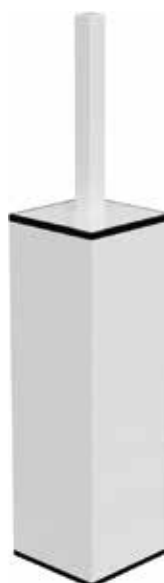

WC šepėčio laikiklis pastatomas/pakabinamas

Toilet brush holder, free standing or hanging

95×380×100 mm

104913124

52 €

104913120

WC šepėčio laikiklis pastatomas/pakabinamas

Toilet brush holder, free standing or hanging

95×385×105 mm

102313064

75 €

102313060

WC šepėčio laikiklis pastatomas/pakabinamas

Toilet brush holder, free standing or hanging

80×400×80 mm

102913094

100 €

Pastatomas laikiklis WC šepėčiui ir popieriui

Free standing toilet paper and brushed holder

250×730×250 mm

104836110

228 €



Stiklinė su laikikliu pakabinama

Toothbrush holder

70×95×105 mm

104110014

31 €

104110010

Dantų šepetėlių laikiklis

Toothbrush holder

105×54×89 mm

104110030

29 €

Stiklinė muilinė pakabinama

Soap dish

110×55×129 mm

104108044

31 €

104108040

Muilinė pakabinama

Soap dish

140×55×125 mm

104108160

37 €



Stiklinis muilo dozatorius MINI pakabinamas

Soap dispenser

75×145×100 mm, 200 ml

104109104

49 €

104109100

Stiklinis muilo dozatorius pakabinamas

Soap dispenser

80×180×105 mm, 230 ml

104109014

50 €

Stiklinis muilo dozatorius pakabinamas

Soap dispenser

80×190×133 mm, 230 ml

104109010

58 €

Stiklinis muilo dozatorius pakabinamas

Soap dispenser, glass

85×114×100 mm, 200 ml

104309320

69 €

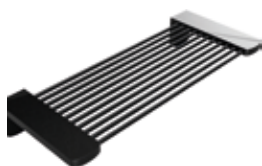
**Lentynėlė**

Shelf

270×40×110 mm

146102270

69 €

**Muilinė kampinė**

Corner Soap dish

262×35×142 mm

102308264

41 €

**Muilinė kampinė**

Corner Soap dish

262×35×142 mm

102308260

41 €

**Muilinė kampinė**

Corner shower shelf

290×47×220 mm

153102390

38 €

**Muilinė stačiakampė**

Shower shelf

300×26×115 mm

102308080

57 €

**Muilinė kampinė**

Corner shower shelf

245×60×150 mm

102308120

43 €

**Muilinė stačiakampė**

Shower shelf

230×30×100 mm

102308070

46 €

**Rankšluosčių laikiklis**

Towel holder

355×55×65 mm

104204010

47 €

**Rankšluosčių laikiklis**

Towel holder

505×55×65 mm

104204024

104204020

47 €

**Rankšluosčių laikiklis**

Towel holder

655×55×65 mm

104204044

104204040

50 €

53 €

**Dvigubas rankšluosčių laikiklis**

Double towel holder

655×55×110 mm

104204050

78 €

**Dvigubas rankšluosčių laikiklis**

Double towel holder, swivel

55×40×420 mm

104204194

55 €

**Dvigubas rankšluosčių laikiklis**

Double towel holder, swivel

55×40×420 mm

104204190

55 €

**Lentyna rankšluosčiams**

Towel holder with rail

550×120×265 mm

104219074

129 €

**Lentyna rankšluosčiams**

Towel holder with rail

550×120×265 mm

104219070

132 €



Stiklinė lentynėlė

Glass shelf
600×55×130 mm
104102044

50 €



Stiklinė lentynėlė

Glass shelf
600×55×130 mm
104102040

50 €



Vonios rankena

Grab bar
470×65×90 mm
104307770

65 €



Žiedinė rankšluosčių pakaba

Ring towel holder
160×175×65 mm
104204060

36 €



Žiedinė rankšluosčių pakaba

Ring towel holder
170×195×55 mm
104104064
104104060

30 €

29 €



Rankšluosčių laikiklis, tvirtinamas prie stiklinių durų

Towel holder for glass door

470×20×133 mm

104204310

69 €

620×20×133 mm

104204320

70 €



Kosmetinis veidrodis, pakabinamas su LED apšvietimu

Cosmetic bath mirror with LED light
255×200×400 mm, ø 200 mm
112101144

216 €



Kosmetinis veidrodis, pakabinamas su LED apšvietimu

Cosmetic bath mirror with LED light
225×200×365 mm, ø 200 mm, 5,6 W
116101770

191 €



Kosmetinis veidrodis pakabinamas

Cosmetic mirror

230×310×450 mm, ø 190 mm

112201514

96 €

112201510

96 €



Kosmetinis veidrodis pakabinamas

Double-sided cosmetic mirror
230×300×430 mm, ø 200 mm
172201510

50 €



Kosmetinis veidrodis, pastatomas

Double-sided cosmetic mirror free standing
232×385×150 mm, ø 200 mm
112201254

55 €



Kosmetinis veidrodis, pastatomas

Cosmetic bath mirror telescopic

232×370×120 mm, ø 200 mm

112201414

71 €

112201410

67 €



Nosinių dozatorius

Paper tissue dispenser, stainless steel
250×75×130 mm
102303020

47 €



Higieninių maišelių laikiklis

Hygienic bag dispenser, plastic
138×99×27 mm
101403030

12 €



Šiukšliadėžė su lėtai užsidarančiu dangčiu

Waste bin "Soft Close"
170×255×170 mm, 3 l
104315020

20 €



Šiukšliadėžė su lėtai užsidarančiu dangčiu

Waste bin "Soft Close"
200×280×200 mm, 5 l

104315014

26 €

104315010

26 €

NEO

Galima klijuoti su vonios reikmenų klijavimo rinkiniu **B**
Can be glued with a set for gluing bathroom accessories



Kabliukas
Single robe hook
55×55×55 mm
104106065



13 €



Kabliukas
Single robe hook
55×55×50 mm
104106025



15 €



Dvigubas kabliukas
Double robe hook
55×55×50 mm
104106035



15 €



Kabliukas
Single robe hook
Ø 16×30 mm
104506095 6 €
Ø 16×55 mm
104106165 8 €

Medžiaga
Material

nerūdijantis
plienas
stainless
steel

stiklo
glass



Trigubas kabliukas
Hanger with 3 hooks, swivel
55×190×110 mm
104206075



47 €



**WC popieriaus laikiklis
su dangteliu**
Paper holder with cover
135×155×90 mm
104112015



40 €



**WC popieriaus laikiklis
be dangtelio**
Paper holder without cover
145×120×98 mm
104112045 26 €
104112045R 26 €



26 €



**WC popieriaus laikiklis
be dangtelio**
Paper holder without cover
175×55×70 mm
104212035 30 €
104212035L 30 €

Paviršiaus apdaila
Surface finish



**WC popieriaus laikiklis
vertikalus**
Spare toilet paper holder
55×165×65 mm
104112035



25 €

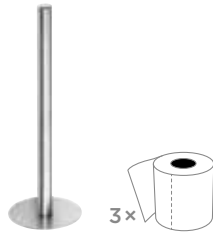

**WC popieriaus laikiklis
pastatomas**
Free standing toilet paper holder
120×352×120 mm
146203165



29 €



Dvigubas popieriaus laikiklis
Double paper holder
320×30×90 mm
146212245



58 €



**WC šepetio laikiklis
pastatomas**
Toilet brush holder, free standing
110×400×130 mm
104113105* 35 €
104113109** 35 €

Sukuotas
Brushed



**WC šepetio laikiklis stiklinis
pakabinamas**
Wall mounted toilet brushed
with glass dish
115×360×130 mm
104113015* 40 €
104113019** 40 €



40 €



**WC šepetio laikiklis
pakabinamas**
Wall mounted toilet brushed
90×380×115 mm
102313075* 70 €
102313079** 70 €



70 €



**WC šepetio laikiklis
pastatomas**
Toilet brush holder, free standing
95×380×95 mm
102313055* 58 €
102313059** 58 €



58 €



**WC šepetio laikiklis
pastatomas/pakabinamas**
Toilet brush holder,
free standing or hanging
95×390×105 mm
102313065* 80 €
102313069** 80 €

* baltas šepetys/white brushed
** juodas šepetys/black brushed



Žiedinė rankšluosčių pakaba

Ring towel holder

160×190×50 mm

104104065

28 €



Stiklinis dozatorius MINI pakabinamas

Soap dispenser MINI with glass

75×145×100 mm, 200 ml

104109115

40 €



Stiklinis dozatorius pakabinamas

Soap dispenser

80×190×133 mm, 230 ml

104109016

55 €



Muilo dozatorius pakabinamas

Soap dispenser

55×175×85 mm, 150 ml

104109015

67 €



Muilo dozatorius pakabinamas JUMBO

Soap dispenser JUMBO

70×230×110 mm, 550 ml

104109035

110 €



Stiklinė muilinė pakabinama

Soap dish

110×55×129 mm

104108045

27 €



Muilinė pakabinama

Soap dish

125×55×115 mm

104208085

30 €



Stiklinė su laikikliu pakabinama

Toothbrush holder

70×95×105 mm

104110015

25 €



Dvigubas dantų šepetėlių laikiklis pakabinamas

Double Toothbrush holder

175×118×90 mm

104210025

45 €



Muilinė stačiakampė

Soap dish

230×30×120 mm

104308072

33 €



Muilinė kampinė

Corner Soap dish

230×30×130 mm

104308172

32 €



Lentynėlė

Shelf

270×40×110 mm

146102275

68 €



Dvigubas rankšluosčių laikiklis

Double towel holder, swivel

55×165×440 mm

104204105

50 €

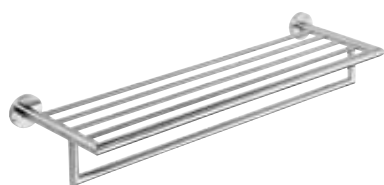

Lentynėlė rankšluosčiams

Towel holder with rail

655×110×215 mm

104205075

110 €

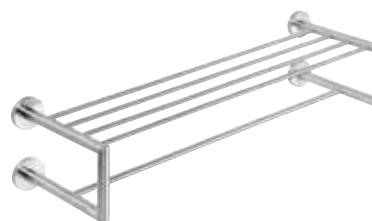

Dviguba lentynėlė rankšluosčiams

Double Towel holder with rail

655×160×225 mm

104205105

133 €

**Rankšluosčių laikiklis**

Towel holder
355×55×65 mm
104204015



40 €

505×55×65 mm

104204125

655×55×65 mm

104204045

43 €

50 €

**Dvigubas rankšluosčių laikiklis**

Double towel holder
655×55×125 mm
104204055



60 €

**Lentynėlė rankšluosčiams**

Towel holder
655×55×215 mm
104205085

98 €

**Vonios rankena**

Grab bar
355×55×75 mm
102307015

43 €

**Kabliukas tvirtinamas ant durų**

Over door hook
20×70×40 mm
104106153

23 €

**Kabliukas tvirtinamas ant durų**

Over door hook
25×85×34 mm
101106155

5 €

**Pakaba tvirtinama ant durų, su 3 kabliukais**

Hanger for door, 3 hooks
175×85×34 mm
101106225

10 €

**Pakaba tvirtinama ant durų, su 6 kabliukais**

Hanger for door, 6 hooks
350×85×34 mm
101106235

14 €

**Pakaba su 4 kabliukais**

Hanger with 4 hooks
270×28×40 mm
104606105

30 €

**Pakaba su 6 kabliukais**

Rail with 6 robe hooks
410×28×40 mm
104606115

40 €

**Stiklinė lentynėlė**

Glass shelf
600×55×130 mm
104102045

40 €

**Kampinė stiklinė lentynėlė**

Corner glass shelf
244×55×244 mm
104102015

46 €

**Kosmetinis veidrodis pakabinamas**

Cosmetic mirror
184×200×412 mm, ø 133 mm
106301705

85 €

**Higieninių maišelių laikiklis**

Hygienic bag dispenser
95×145×30 mm
101403035

46 €

**Nosinių dozatorius**

Handkerchief dispenser
250×130×75 mm
102303025

73 €

BETA



Kabliukas
Single robe hook
55×55×50 mm
132106022

17 €



Dvigubas kabliukas
Double robe hook
55×55×50 mm
132106032

20 €



Trigubas kabliukas
Hanger with 3 hooks, swivel
55×190×135 mm
132206072

45 €



Dvigubas kabliukas
Hanger with 2 hooks
55×120×90 mm
132405222

33 €

Medžiaga
Material

zavaris
brass

stiklo
glass



Pakaba su 2 kabliukais
Hanger with 2 hooks
120×55×50 mm
132405202

30 €



Pakaba su 3 kabliukais
Hanger with 3 hooks, swivel
185×55×50 mm
132405232

44 €



Pakaba su 4 kabliukais
Hanger with 4 hooks
250×55×50 mm
132405212

58 €

Paviršiaus apdaila
Surface finish

chromas
chrome



Blizgus
Polished



Kabliukas
Single robe hook
19×35×38 mm
132106132

14 €



Kabliukas
Single robe hook
55×55×50 mm
132306172

18 €



WC popieriaus laikiklis su dangteliu
Paper holder with cover
138×150×80 mm
132112012

40 €



WC popieriaus laikiklis be dangtelio
Paper holder without cover
135×100×90 mm
132112042

30 €



WC popieriaus laikiklis be dangtelio
Paper holder
180×55×70 mm
132212032
132212032L

33 €



WC popieriaus laikiklis vertikalus
Spare toilet paper holder
55×165×65 mm
132112032

25 €



Žiedinė rankšluosčių pakaba
Ring towel holder
168×188×50 mm
132104062

30 €



Pakaba su 5 kabliukais
Hanger with 5 hooks
415×55×70 mm
132105112

43 €



WC šepetėlio laikiklis stiklinis pakabinamas
Wall mounted toilet brush holder
95×360×140 mm
132113012*
132113017**

44 €

44 €



WC šepetėlio laikiklis pastatomas/pakabinamas
Toilet brush holder
free standing/wall mounted
85×440×85 mm
118113092

82 €



WC šepetėlio laikiklis pastatomas/pakabinamas
Toilet brush holder
free standing/wall mounted
80×360×80 mm
118213092

109 €



WC šepetėlio laikiklis pastatomas/pakabinamas
Toilet brush holder
free standing/wall mounted
80×400×80 mm
135913091

64 €



Pastatomas WC šepėčio ir popieriaus laikiklis

Free standing stand toilet paper holder and toilet brushed

150×710×255 mm
132836042

212 €



Stiklinė muilinė pakabinama

Soap dish
110×55×129 mm
132108042

28 €



Muilinė stačiakampė pakabinama

Soap dish
129×55×110 mm
132208082

28 €

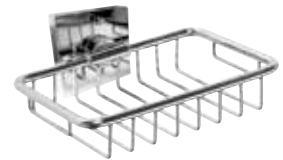

Muilinė pakabinama

Soap dish
140×52×125 mm
132108162

32 €



Laikiklis-magnetis muilui

Magnetic soap holder
55×55×70 mm
132108202

28 €



Stiklinis dozatorius pakabinamas

Soap dispenser
80×190×133 mm, 230 ml
132109017

58 €



Stiklinis pakabinamas muilo dozatorius su magnetu muilui

Soap dispenser with magnetic soap holder
75×160×100 mm, 200 ml
132109182

75 €



Stiklinis dozatorius pakabinamas

Soap dispenser
70×145×100 mm, 200 ml
132109102

48 €



Stiklinė su laikikliu pakabinama

Toothbrush holder
70×95×105 mm
132110012

30 €



Laikiklis su 2 stiklinėmis pakabinamas

Double Toothbrush holder
160×95×90 mm
132110022

45 €



Pastatomas WC šepėčio ir popieriaus laikiklis

Free standing stand toilet paper holder and toilet brushed

150×710×255 mm
132836012

195 €



Dantų šepetėlių laikiklis su 2 stiklinėmis pakabinamas

Double Toothbrush holder
190×95×125 mm
132110042

60 €



Dantų šepetėlių laikiklis pakabinamas

Toothbrush holder
105×55×85 mm
132110032

24 €



Stiklinė lentynėlė

Glass shelf
300×55×130 mm
132122042

42 €



Kampinė stiklinė lentynėlė

Corner glass shelf
255×55×255 mm
132102012

45 €



Stiklinė lentynėlė

Glass shelf
600×55×130 mm
132102042

45 €



Stiklinė lentynėlė

Glass shelf with rail
600×55×130 mm
132102212

70 €

* baltas šepetys/white brushed

** juodas šepetys/black brushed



Rankšluosčių laikiklis

Towel holder

355 x 55 x 65 mm

132104012

35 €

505 x 55 x 65 mm

132104022

38 €

655 x 55 x 65 mm

132104042

43 €



Dvigubas rankšluosčių laikiklis

Double towel holder

655x55x110 mm

132104052

50 €



Vonios rankena

Grab bar

355x55x80 mm

132307611

60 €



Rankšluosčių laikiklis

Towel holder

355x55x65 mm

132204012

39 €

505x55x65 mm

132204022

44 €

655x55x65 mm

132204042

50 €



Dvigubas rankšluosčių laikiklis

Double towel holder

655x55x120 mm

132204052

62 €



Lentynėlė rankšluosčiams

Towel holder

655x55x215 mm

132205082

91 €



Lentynėlė rankšluosčiams

Towel holder with rail

655x106x215 mm

132205072

113 €



Dviguba lentynėlė rankšluosčiams

Double Towel holder with rail

655x160x225 mm

132205102

133 €



Dvigubas rankšluosčių laikiklis

Double towel holder, swivel

55x55x420 mm

132204191

49 €



Dvigubas rankšluosčių laikiklis

Double towel holder, swivel

55x165x450 mm

132204102

65 €



Dušo stovas, chromas

Shower rod with slider

90x900x110 mm

132114122

100 €



Kosmetinis veidrodis pakabinamas

One-sided cosmetic mirror

200x550x140 mm

132201172

178 €



Plaukų džiovintuvo laikiklis

Hairdryer holder

80x55x100 mm

132117012

30 €



Dvigubas pastatomas rankšluosčių laikiklis

Free standing double towel holder

150x800x400 mm

132836022

195 €



Plaukų džiovintuvo laikiklis

Hairdryer holder, spiral

105x118x123 mm

132117022

34 €



Laikikliai lentynos (2 vnt)

Glass shelf holder BETA (2 pcs.)

55x55x40 mm ± 8 mm

132102112

33 €

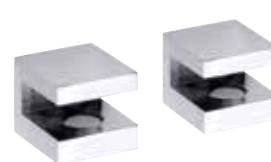

Laikikliai lentynos (2 vnt)

Glass shelf holder (2 pcs.)

20x20x25 mm ± 6 až 8 mm

102202112

18 €

easy / easy01

163XXXXXX - 

164XXXXXX - 



163109220
juoda/black

163109221
blizgus/polished



Kabliukas, juoda

Single robe hook, black
45×45×38 mm

163106260
164106260

11 €
11 €

Kabliukas, blizgus

Single robe hook, polished
45×45×38 mm

163106261
164106261

10 €
10 €

Kabliukas, matinis

Single robe hook, brushed
45×45×38 mm

163106265
164106265

9 €
9 €

Medžiaga
Material
nerūdijantis
plienas
stainless
steel



Muilo dozatorius

Soap dispenser
66×165×120 mm, 300 ml

163109220
163109221

85 €
85 €

Kabliukas, juoda

Single robe hook, black
45×45×40 mm

163106360
164106360

8 €
8 €

Kabliukas, blizgus

Single robe hook, polished
45×45×40 mm

163106361
164106361

7 €
7 €

Kabliukas, matinis

Single robe hook brushed
45×45×40 mm

163106365
164106365

7 €
7 €

Paviršius apdaila
Surface finish



Juoda
Black



Blizgus
Polished



Šukuotas
Brushed

163109090
juoda/black

163109091
blizgus/polished



Pakaba su 2 kabliukais, juoda

Hanger with 2 hooks, black
115×45×38 mm

163106270
164106270

21 €
21 €

Pakaba su 2 kabliukais, blizgi

Hanger with 2 hooks, polished
115×45×38 mm

163106271
164106271

19 €
19 €

Pakaba su 2 kabliukais, matinė

Hanger with 2 hooks, brushed
115×45×38 mm

163106275
164106275

17 €
17 €

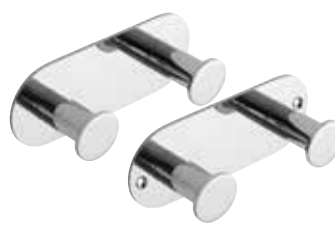
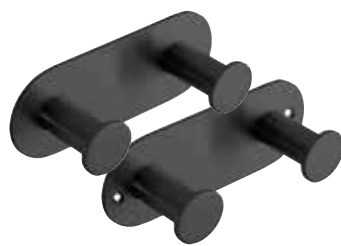

Muilo dozatorius

Soap dispenser
66×235×120 mm, 500 ml

163109090
163109091

97 €
97 €

Pakaba su 2 kabliukais, juoda

Hanger with 2 hooks, black
115×45×31 mm

163106370
164106370

20 €
20 €

Pakaba su 2 kabliukais, blizgi

Hanger with 2 hooks, polished
115×45×31 mm

163106371
164106371

17 €
17 €

Pakaba su 2 kabliukais, matinė

Hanger with 2 hooks, brushed
115×45×31 mm

163106375
164106375

14 €
14 €



Pakaba su 4 kabliukais, juoda

Hanger with 4 hook, black
255×45×38 mm

163106290
164106290

35 €
35 €

Pakaba su 4 kabliukais, blizgi

Hanger with 4 hook, polished
255×45×38 mm

163106291
164106291

31 €
31 €

Pakaba su 4 kabliukais, matinė

Pakaba su 4 kabliukais, mat
255×45×38 mm

163106295
164106295

29 €
29 €



Pakaba su 4 kabliukais, juoda

Hanger with 4 hook, black
255×45×31 mm

163106390 34 €
164106390 34 €



Pakaba su 4 kabliukais, blizgi

Hanger with 4 hook, polished
255×45×31 mm

163106391 29 €
164106391 29 €



Pakaba su 4 kabliukais, matinis

Hanger with 4 hook, brushed
255×45×31 mm

163106395 27 €
164106395 27 €



WC popieriaus laikiklis, juodas

Toilet paper holder, black
145×100×42 mm

163112220 33 €
164112220 33 €



WC popieriaus laikiklis, blizgus

Toilet paper holder, polished
145×100×42 mm

163112221 28 €
164112221 28 €



WC popieriaus laikiklis, matinis

Toilet paper holder, brushed
145×100×42 mm

163112225 27 €
164112225 27 €



WC popieriaus laikiklis, juodas

Toilet paper holder, black
145×100×42 mm

163112020 33 €
164112020 33 €



WC popieriaus laikiklis, blizgus

Toilet paper holder, polished
145×100×42 mm

163112021 28 €
164112021 28 €



WC popieriaus laikiklis, matinis

Toilet paper holder, brushed
145×100×42 mm

163112025 27 €
164112025 27 €



WC popieriaus laikiklis vertikalus, juodas

Spare toilet paper holder, black
45×180×74 mm

163112230 18 €
164112230 18 €



WC popieriaus laikiklis vertikalus, blizgus

Spare toilet paper holder, polished
45×180×74 mm

163112231 17 €
164112231 17 €



WC popieriaus laikiklis vertikalus, matinis

Spare toilet paper holder, brushed
45×180×74 mm

163112235 15 €
164112235 15 €



WC popieriaus laikiklis, vertikalus, juodas

Spare toilet paper holder, black
45×180×74 mm

163112030 18 €
164112030 18 €



WC popieriaus laikiklis vertikalus, blizgus

Spare toilet paper holder, polished
45×180×74 mm

163112031 17 €
164112031 17 €



WC popieriaus laikiklis vertikalus, matinis

Spare toilet paper holder, brushed
45×180×74 mm

163112035 15 €
164112035 15 €



WC šepėčio laikiklis pakabinamas, juodas

Wall mounted toilet brush holder, black
80×355×97 mm / 105×355×96

163113060
164113060

46 €
46 €



WC šepėčio laikiklis pakabinamas, blizgus

Wall mounted toilet brush holder, polished
80×355×97 mm / 105×355×96

163113061
164113061

39 €
39 €



WC šepėčio laikiklis pakabinamas, matinis

Wall mounted toilet brush holder, brushed
80×355×97 mm / 105×355×96

163113065
164113065

35 €
35 €



Rankšluosčių laikiklis, juodas

Towel holder, black
645×72×74 mm

163104040
164104040

36 €
36 €



Rankšluosčių laikiklis, juodas

Towel holder, black
645×72×74 mm

163104240
164104240

36 €
36 €



Rankšluosčių laikiklis, blizgus

Towel holder, polished
645×72×74 mm

163104041
164104041

31 €
31 €



Rankšluosčių laikiklis, blizgus

Towel holder, polished
645×72×74 mm

163104241
164104241

31 €
31 €



Rankšluosčių laikiklis, matinis

Towel holder, brushed
645×72×74 mm

163104045
164104045

28 €
28 €



Rankšluosčių laikiklis, matinis

Towel holder, brushed
645×72×74 mm

163104245
164104245

28 €
28 €

NIVA

Design by doc. MgA. René Šulc



Medžiaga
Material

nerūdijantis
plienas
stainless
steel

3M

Paviršiaus apdaila
Surface finish



Šukuotas
Brushed

Dvigubas kabliukas

Double robe hook

48×85×22 mm

101106035

12 €

Pakaba su 5 kabliukais

Hanger with 5 hooks

180×70×22 mm

101106045

27 €

WC popieriaus laikiklis

Paper holder

155×57×80 mm

101106025

23 €



Lentynėlė

Shelf

180×50×97 mm

101102365

26 €

Muilo dozatorius

Soap dispenser

66×165×120 mm, 300 ml

101109225

75 €

Muilo dozatorius

Soap dispenser

66×235×120 mm, 500 ml

101109095

85 €

Lentynėlė

Shelf

300×50×97 mm

101102225

38 €

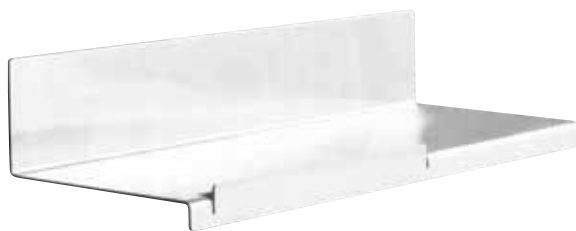

WC popieriaus laikiklis su lentynėle

Toilet paper holder with shelf

270×57×80 mm

101104015

33 €



Rankšluosčių laikiklis

Towel holder

335×50×70 mm

101112135

35 €

WC šepetio laikiklis pakabinamas

Wall mounted toilet brushed

130×353×120 mm

101113091

69 €

VIA



Kabliukas
Single robe hook
17×38×30 mm
135006012

10 €



Dvigubas kabliukas
Double robe hook
37×26×30 mm
135006232

14 €



Kabliukas
Single robe hook
25×70×48 mm
102306172

14 €



Dvigubas kabliukas
Double robe hook
80×28×39 mm
135006032

18 €



WC popieriaus laikiklis be dangtelio
Paper holder without cover
179×28×59 mm
135012022
135012022L

28 €
28 €



WC popieriaus laikiklis be dangtelio
Paper holder without cover
131×90×75 mm
135012222

32 €



WC popieriaus laikiklis su dangteliu
Paper holder with cover
130×95×90 mm
135012012

43 €

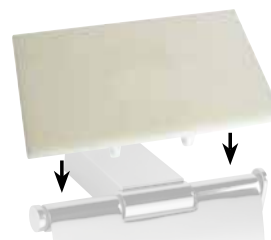

Lentynėlė mobiliam telefonui ant wc popieriaus laikiklio
Mobile phone shelf for toilet paperholder
132×27×78 mm
131567032

10 €



WC šepėčio laikiklis stiklinis pakabinamas
Wall mounted toilet brush holder
93×385×127 mm
135013012

50 €



WC šepėčio laikiklis pastatomas/pakabinamas
Toilet brush holder free standing/wall mounted
85×440×85 mm
118113092

82 €



WC šepėčio laikiklis pastatomas/pakabinamas
Toilet brush holder free standing/wall mounted
80×365×80 mm
118213092

109 €



WC šepėčio laikiklis pastatomas/pakabinamas
Toilet brush holder free standing/wall mounted
80×400×80 mm
135913091

64 €

Medžiaga
Material

žalvaris
brass

stiklo
glass

Paviršiaus apdaila
Surface finish

chromas
chrome



Blizgus
Polished



WC popieriaus laikiklis vertikalus

Spare toilet paper holder

20×178×59 mm

135112032

28 €

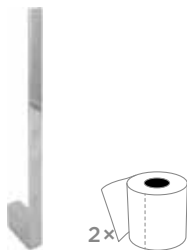

WC popieriaus laikiklis, prailgintas

Spare toilet paper holder, extended

20×300×59 mm

135012032

38 €



Stiklinis muilo dozatorius pakabinamas

Soap dispenser

65×150×120 mm, 250 ml

135009042

53 €



Stiklinė su laikikliu pakabinama

Toothbrush holder

63×100×97 mm

135011012

35 €



Stiklinė muilinė pakabinama

Soap dish

103×42×117 mm

135008022

35 €



Pakaba su 3 kabliukais

Hanger with 3 hooks

174×30×37 mm

135006242

35 €



Pakaba su 6 kabliukais

Hanger with 5 hooks

301×30×37 mm

135006252

63 €



Rankšluosčių laikiklis

Towel holder

135004022

135004042

59 €

69 €

135004043

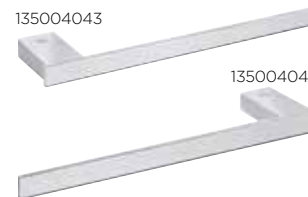

135004044

Rankšluosčių laikiklis

Towel holder

297×20×59 mm

135004043

135004044

38 €

38 €



Dvigubas rankšluosčių laikiklis

Double towel holder, swivel

46×32×445 mm

135004102

79 €



Dvigubas rankšluosčių laikiklis

Double towel holder

500×20×132 mm

135004082

99 €



Žiedinė rankšluosčių pakaba

Ring towel holder

220×20×100 mm

135004062

45 €



Lentynėlė rankšluosčiams

Towel holder

500×20×205 mm

135002182

139 €



Stiklinė lentynėlė

Glass shelf

600×19×118 mm

135002242

500×19×118 mm

135002352

35 €

34 €



Vonios rankena

Grab bar

320×40×60 mm

135007072

84 €

NERO



Kabliukas
Single robe hook
17×38×30 mm
135006010



Dvigubas kabliukas
Double robe hook
37×26×30 mm
135006030



Dvigubas kabliukas
Double robe hook
37×26×30 mm
135006230



Kabliukas
Single robe hook
25×67×32 mm
135106020



Dvigubas kabliukas
Double robe hook
83×46×33 mm
135106030



Pakaba su keturiais kabliukais
Rail with 4 robe hooks
205×46×33 mm
135105210



WC popieriaus laikiklis be dangtelio
Paper holder
179×28×59 mm
135012020



WC popieriaus laikiklis be dangtelio
Paper holder without cover
131×90×75 mm
135012220



WC popieriaus laikiklis su dangteliu
Paper holder with cover
130×95×90 mm
135012010



WC popieriaus laikiklis vertikalus
Spare toilet paper holder
20×1780×59 mm
135112030



WC šepetio laikiklis pastatomas/pakabinamas
Toilet brush holder, wall mounted/free standing
85×375×85 mm
135913160



WC šepetio laikiklis stiklinis pakabinamas
Wall mounted toilet brush holder
93×385×127 mm
135013010



WC šepetio laikiklis pastatomas/pakabinamas
Toilet brush holder free standing/wall mounted
80×400×80 mm
135913090

Medžiaga
Material

žalvaris
brass

stiklo
glass

Paviršiaus apdaila
Surface finish

lygus
lakas
lacquer

Matinis
Matt



Stiklinė muilinė pakabinama

Soap dish
103×42×117 mm
135008020

35 €



Stiklinė su laikikliu pakabinama

Toothbrush holder
64×100×97 mm
135011010

35 €



Stiklinis muilo dozatorius pakabinamas

Soap dispenser
75×116×95 mm, 250 ml
139309310

75 €

Stiklinis muilo dozatorius pakabinamas

Soap dispenser
65×150×120 mm
135009040

75 €



Vonios rankena

Grab bar
320×40×60 mm
135507670

60 €

68 €



Žiedinė rankšluosčių pakaba

Ring towel holder
220×20×110 mm
135004060

46 €

Rankšluosčių laikiklis

Towel holder
600×20×59 mm
135004040

68 €



Dvigubas rankšluosčių laikiklis

Double towel holder, swivel
47×34×445 mm
135004100

95 €

Dvigubas rankšluosčių laikiklis

Double towel holder
500×20×132 mm
135004080

104 €

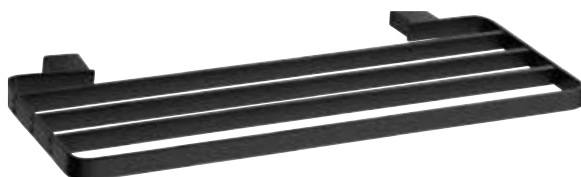

Lentynėlė rankšluosčiams

Towel holder
500×20×205 mm
135002180

143 €

Stiklinė lentynėlė

Glass shelf
600×19×118 mm
135002240

40 €

SOLO



Kabliukas
Single robe hook
47×47×35 mm
139106172

7 €



Kabliukas
Single robe hook
25×67×32 mm
139106022

11 €



Dvigubas kabliukas
Hanger with 2 hooks
83×46×33 mm
139106032

16 €



Pakaba su 4 kabliukais
Hanger with 4 hooks
205×46×33 mm
139105212

31 €

Medžiaga
Material

žalvaris
brass

stiklo
glass

Paviršiaus apdaila
Surface finish

chromas
chrome



Blizgus
Polished



WC popieriaus laikiklis be dangtelio
Paper holder without cover
129×25×82 mm
139112022

28 €



WC popieriaus laikiklis su dangteliu
Paper holder with cover
128×64×130 mm
139112012

44 €



WC šepetio laikiklis stiklinis pakabinamas
Wall mounted toilet brush holder
83×390×93 mm
139113142

42 €



WC šepetio laikiklis pastatomas/pakabinamas
Toilet brush holder, free standing or hanging
85×375×85 mm
139113162

88 €



Stiklinė muilinė pakabinama
Soap dish
104×45×110 mm
139108032

28 €



Stiklinė su laikikliu pakabinama
Toothbrush holder
75×101×91 mm
139110012

28 €



Stiklinis dozatorius pakabinamas
Soap dispenser
75×170×91 mm, 200 ml
139309312

78 €



Stiklinis dozatorius pakabinamas
Soap dispenser
75×170×91 mm
139109042

43 €



Žiedinė rankšluosčių pakaba
Ring towel holder
200×25×82 mm
139104062

35 €



Rankšluosčių laikiklis
Towel holder
600×25×80 mm
139104282

86 €



Rankšluosčių laikiklis
Towel holder
800×25×80 mm
139104412

96 €



Dvigubas rankšluosčių laikiklis
Double towel holder
600×25×130 mm
139104052

104 €



Dvigubas rankšluosčių laikiklis
Towel holder
50×35×393 mm
139104232

62 €



Dvigubas rankšluosčių laikiklis
Double towel holder, swivel
398,5×47,2×83 mm
139104102

52 €



Lentynėlė rankšluosčiams
Towel holder with rail
600×108×255 mm
139105262

227 €



Stiklinė lentynėlė
Glass shelf
500×25×110 mm
139102312

122 €

ALFA / NOX



Dvigubas kabliukas

Double robe hook

70×60×50 mm

102406022

10 €

102406020

10 €



WC popieriaus laikiklis be dangtelio

Paper holder without cover

180×125×60 mm

102414012

18 €



WC popieriaus laikiklis be dangtelio

Toilet paper holder without cover

138×103×55 mm

102414010

18 €



WC popieriaus laikiklis su dangteliu

Paper holder with cover

138×135×59 mm

102512012

20 €

Medžiaga
Material

cinko
zinc

stiklo
glass

Paviršiaus apdaila
Surface finish

Blizgus
Polished

Matinis
Matt



WC popieriaus laikiklis su dangteliu

Toilet paper holder with cover

138×135×59 mm

102512010

20 €



WC popieriaus laikiklis vertikalus

Paper holder without cover

60×168×75 mm

102512032

15 €



WC šepetio laikiklis stiklinis pakabinamas

Wall mounted toilet brush holder

115×385×140 mm

102413012

32 €



WC šepetio laikiklis stiklinis pakabinamas

Wall mounted toilet brush holder

113×385×150 mm

102413010

32 €



Stiklinė su laikikliu pakabinama

Toothbrush holder

68×95×115 mm

102410012

15 €

102410010

15 €



Stiklinis dozatorius pakabinamas

Soap dispenser

68×150×115 mm, 200 ml

102408022

30 €



Stiklinis dozatorius pakabinamas

Soap dispenser

68×165×125 mm, 200 ml

102408020

30 €



Stiklinė muilinė pakabinama

Soap dish

110×60×138 mm

102408023

16 €

102408030

16 €



Rankšluosčių laikiklis

Towel holder

610×60×75 mm

102404282

29 €



Dvigubas rankšluosčių laikiklis

Double towel holder

600×60×155 mm

102410052

41 €



Dvigubas rankšluosčių laikiklis

Double towel holder, swivel

60×65×475 mm

102404101

28 €



Žiedinė rankšluosčių pakaba

Ring towel holder

212×170×55 mm

102502062

21 €



Stiklinė lentynėlė

Glass shelf

600×22×125 mm

102402242

34 €



Stiklinė lentynėlė

Glass shelf with tilttable rail

620×60×150 mm

102402243

51 €

PLaza

MB



Dvigubas kabliukas

Double robe hook

78×35×50 mm

118106032

32 €

118112012



WC popieriaus laikiklis su dangteliu

Paper holder with cover

125×125×65 mm

118112012

118112012H

42 €



118112012H



WC popieriaus laikiklis be dangteliu

Paper holder without cover

190×35×70 mm

118112022

35 €

40 €



WC šepetio laikiklis stiklinis pakabinamas

Wall mounted toilet brush holder

115×360×150 mm

118113012

70 €



WC šepetio laikiklis pastatomas/pakabinamas

Toilet brush holder free standing/wall mounted

85×440×85 mm

118113092

82 €



WC šepetio laikiklis pastatomas/pakabinamas

Toilet brush holder free standing/wall mounted

80×375×80 mm

118213092

109 €



Stiklinė muilinė pakabinama

Soap dish

100×48×130 mm

118108022

44 €



Stiklinis dozatorius pakabinamas

Soap dispenser

60×165×95 mm, 200 ml

118209049

58 €



Muilo dozatorius pastatomas

Soap dispenser

105×160×90 mm, 230 ml

118109042

58 €



Stiklinė su laikikliu pakabinama

Toothbrush holder

85×100×120 mm

118110052

44 €



Stiklinė su laikikliu pakabinama

Toothbrush holder

60×100×95 mm

118210019

44 €



Stiklinė muilinė pastatoma

Glass soap dish free standing

103×55×103 mm

140108191

46 €



Muilo dozatorius pastatomas

Soap dispense, free standing

75×180×75 mm, 200 ml

140109161

69 €



Stiklinė su laikikliu pastatoma

Toothbrush holder, free standing

75×170×75 mm, 200 ml

140110061

47 €



Žiedinė rankšluosčių pakaba

Ring towel holder

210×135×65 mm

118104062

53 €



Rankšluosčių laikiklis

Towel holder

350×35×70 mm

118104252

29 €

625×35×70 mm

118104042

65 €



Dvigubas rankšluosčių laikiklis

Double towel holder

625×35×120 mm

118104052

99 €



Lentynė rankšluosčiams

Towel holder with rail

585×140×210 mm

118104122

224 €



Stiklinė lentynė

Glass shelf

520×35×139 mm

118102042

47 €

Medžiaga
Material

žalvaris
brass

stiklo
glass

Paviršius apdaila
Surface finish

chromas
chrome

Blizgus
Polished

oval

! Išpardavimas, prekių kiekis ribotas.
! Till sold out.

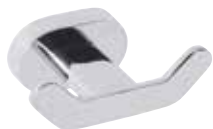

Dvigubas kabliukas

Double robe hook

80×25×50 mm

118406031

30 €



WC popieriaus laikiklis be dangtelio

Paper holder without cover

190×30×65 mm

118412021

40 €



WC šepetio laikiklis stiklinis pakabinamas

Wall mounted toilet brush holder

95×360×130 mm

118413011

58 €



WC popieriaus laikiklis su dangteliu

Paper holder with cover

125×130×60 mm

118412011

43 €



Žiedinė rankšluosčių pakaba

Ring towel holder

330×220×65 mm

118404061

50 €



Stiklinė muilinė pakabinama

Soap dish

130×35×105 mm

118408021

39 €



Stiklinė su laikikliu pakabinama

Toothbrush holder

70×100×105 mm

118410011

34 €



Muilinė pakabinama

Soap dish

135×30×130 mm

118408041

49 €



Stiklinis dozatorius pakabinamas

Soap dispenser

75×170×110 mm, 200 ml

118409011

50 €



Stiklinė lentynėlė

Glass shelf

520×30×145 mm

118402031

55 €



Rankšluosčių laikiklis

Towel holder

610×35×65 mm

118404041

73 €



Dvigubas rankšluosčių laikiklis

Double towel holder

650×30×110 mm

118404051

110 €



Lentynėlė rankšluosčiams

Towel holder

650×30×200 mm

118412181

199 €

Tasi



Kabliukas
Single robe hook
50×50×57 mm
154106062

14 €



Dvigubas kabliukas
Hanger with 2 hooks
80×50×60 mm
154106032

20 €



WC popieriaus laikiklis su dangteliu
Paper holder with cover
137×144×78 mm
154112012

40 €



WC popieriaus laikiklis be dangtelio
Paper holder without cover
137×130×66 mm
154112022

29 €



Stiklinė su laikikliu pakabinama
Toothbrush holder
67×96×107 mm
154110012

29 €



Stiklinis muilo dozatorius pakabinamas
Soap dispenser
82×192×130 mm, 230 ml
154109042

46 €



Stiklinė muilinė pakabinama
Soap dish
110×52×129 mm
154108022

29 €



WC šepečio laikiklis stiklinis pakabinamas
Wall mounted toilet brush holder
110×370×145 mm
154113012

41 €



Stiklinė lentynėlė
Glass shelf
600×50×132 mm
154102242

41 €



Žiedinė rankšluosčių pakaba
Ring towel holder
205×146×60 mm
154104062

35 €



Rankšluosčių laikiklis
Towel holder
656×50×87 mm
154104042

41 €



Lentynėlė rankšluosčiams
Towel holder with rail
656×105×216 mm
154105262

95 €

Medžiaga
Material

žalvaris
brass

stiklo
glass

Paviršiaus apdaila
Surface finish

chromas
chrome



Blizgus
Polished

NIKI



Medžiaga
Material

cinko
zinc

stiklo
glass

Paviršiaus apdaila
Surface finish

Blizgus
Polished

Dvigubas kabliukas

Double robe hook

84×36×60 mm

153106032

12 €

WC popieriaus laikiklis su dangteliu

Paper holder with cover

117×140×49 mm

153112012

15 €

WC popieriaus laikiklis be dangtelio

Paper holder without cover

126×90×42 mm

153112022

12 €



Žiedinė rankšluosčių pakaba

Ring towel holder

228×150×60 mm

153104062

23 €

Pakaba su 4 kabliukais

Hanger with 4 hooks

300×53×45 mm

153105112

23 €



Stiklinė muilinė pakabinama

Soap dish

100×40×110 mm

153108022

20 €

Stiklinė su laikikliu pakabinama

Toothbrush holder

77×97×100 mm

153110052

20 €

WC šepetio laikiklis stiklinis pakabinamas

Wall mounted toilet brush holder

105×375×135 mm

153113012

35 €



Stiklinis dozatorius pakabinamas

Soap dispenser

77×150×100 mm, 250 ml

153209049

29 €

Stiklinė lentynėlė

Glass shelf

500×36×115 mm

153102042

23 €

Rankšluosčių laikiklis

Towel holder

550×36×62 mm

153104042

30 €



Dvigubas rankšluosčių laikiklis

Double towel holder

550×36×117 mm

153104052

50 €

Dvigubas rankšluosčių laikiklis

Double towel holder, swivel

50×53×475 mm

153104191

20 €

Trigubas rankšluosčių laikiklis

Triple towel holder swiveling

42×175×350 mm

153104112

25 €



Kabliukas
Single robe hook
66×66×74 mm
144706017

29 €



WC popieriaus laikiklis vertikalus
Toiletpaper holder
66×181×74 mm
144712037

42 €



WC popieriaus laikiklis be dangtelio
Paper holder without cover
136×102×93 mm
144712027

41 €



WC popieriaus laikiklis su dangteliu
Paper holder with cover
136×156×95 mm
144712017

62 €



WC šepetčio laikiklis stiklinis pakabinamas
Wall mounted toilet brush with ceramic dish
107×385×156 mm
144713017

62 €



Stiklinė muilinė pakabinama
Soap dish
107×66×150 mm
144708027

42 €



Stiklinė su laikikliu pakabinama
Toothbrush holder
73×123×135 mm
144710017

42 €



Laikiklis su 2 stiklinėmis
Double toothbrush holder
168×107×95 mm
144710027

65 €



Stiklinis dozatorius pakabinamas
Soap dispenser
72×190×125 mm, 230 ml
144709017

67 €



Rankšluosčių laikiklis
Towel holder
666×66×74 mm
144704047

72 €



Žiedinė rankšluosčių pakaba
Ring towel holder
168×200×74 mm
144704067

48 €



Dvigubas rankšluosčių laikiklis
Double towel holder
666×66×152 mm
144704057

95 €



Lentynėlė rankšluosčiams
Towel holder
666×66×245 mm
144702187

156 €

Medžiaga
Material

žalvaris
brass

keramika
ceramics

Paviršiaus apdaila
Surface finish

bronzą
brass

Šukuotas
Brushed

RETRO



chromas
chrome
1443XXXXX



auksas/chromas
gold/chrome
1442XXXXX



bronz
bronze
1441XXXXX

Medžiaga
Material

žalvaris
brass

stiklo
glass



Paviršius apdaila
Surface finish

Kabliukas

Single robe hook

65×65×65 mm

- 144306132 chromas/chrome
- 144206138 auksas/chromas, gold/chrome
- 144106137 bronz/bronze

- 18 €
- 24 €
- 27 €

Kabliukas

Single robe hook

65×65×65 mm

- 144306012 chromas/chrome
- 144206018 auksas/chromas, gold/chrome
- 144106017 bronz/bronze

- 20 €
- 23 €
- 30 €

chromas
chrome

Blizgus
Polished

titano/
chromas
titanium/
chrome

Blizgus
Polished

bronz
bronze

Šukuotas
Brushed



Dvigubas kabliukas

Double robe hook

65×65×65 mm

- 144306032 chromas/chrome
- 144206038 auksas/chromas, gold/chrome
- 144106037 bronz/bronze

- 23 €
- 27 €
- 33 €

WC popieriaus laikiklis su dangteliu

Paper holder with cover

140×150×100 mm

- 144312012 chromas/chrome
- 144212018 auksas/chromas, gold/chrome
- 144112017 bronz/bronze

- 42 €
- 50 €
- 63 €



WC popieriaus laikiklis be dangtelio

Paper holder without cover

135×100×90 mm

- 144312022 chromas/chrome
- 144212028 auksas/chromas, gold/chrome
- 144112027 bronz/bronze

- 31 €
- 37 €
- 48 €

WC popieriaus laikiklis vertikalus

Spare toilet paper holder

65×170×65 mm

- 144312032 chromas/chrome
- 144212038 auksas/chromas, gold/chrome
- 144112037 bronz/bronze

- 30 €
- 35 €
- 47 €

WC šepėčio laikiklis stiklinis pakabinamas

Wall mounted toilet brush holder

110×360×145 mm

- 144313012 chromas/chrome
- 144213018 auksas/chromas, gold/chrome
- 144113017 bronz/bronze

- 48 €
- 50 €
- 68 €

Žiedinė rankšluosčių pakaba

Ring towel holder

160×190×65 mm

- 144304062 chromas/chrome
- 144204068 auksas/chromas, gold/chrome
- 144104067 bronz/bronze

- 34 €
- 38 €
- 49 €



**Stiklinė muilinė pakabinama**

Soap dish

110×65×138 mm

144308022 chromas/chrome

144208028 auksas/chromas, gold/chrome

144108027 bronzą/bronze

**Muilinė pakabinama**

Soap dish

140×65×142 mm

32 € 144308162 chromas/chrome

37 € 144208168 auksas/chromas, gold/chrome

42 € 144108167 bronzą/bronze

37 €

40 €

55 €

**Stiklinis muilo dozatorius MINI pakabinamas**

Soap dispenser MINI with glass

75×150×120 mm, 200 ml

144309102 chromas/chrome

144209108 auksas/chromas, gold/chrome

144109107 bronzą/bronze

63 €

74 €

77 €

**Stiklinis muilo dozatorius pakabinamas**

Soap dispenser

80×190×120 mm, 230 ml

144309012 chromas/chrome

144209018 auksas/chromas, gold/chrome

144109017 bronzą/bronze

65 €

80 €

78 €

**Stiklinė su laikikliu pakabinama**

Toothbrush holder

70×95×115 mm

144310012 chromas/chrome

144210018 auksas/chromas, gold/chrome

144110017 bronzą/bronze

32 €

37 €

43 €

**Laikiklis su 2 stiklinėmis pakabinamas**

Double Toothbrush holder

175×95×90 mm

144310022 chromas/chrome

144210028 auksas/chromas, gold/chrome

144110027 bronzą/bronze

48 €

50 €

65 €

**Rankšluosčių laikiklis**

Towel holder

365×65×65 mm

144304012 chromas/chrome

144204018 auksas/chromas, gold/chrome

144104017 bronzą/bronze

38 €

50 €

65 €

**Rankšluosčių laikiklis**

Towel holder

665×65×65 mm

144304042 chromas/chrome

144204048 auksas/chromas, gold/chrome

144104047 bronzą/bronze

49 €

60 €

77 €

**Dvigubas rankšluosčių laikiklis**

Double towel holder

665×65×120 mm

144304052 chromas/chrome

144204058 auksas/chromas, gold/chrome

144104057 bronzą/bronze

87 €

85 €

100 €

**Lentynėlė rankšluosčiams**

Towel holder

665×65×225 mm

144302182 chromas/chrome

144202188 auksas/chromas, gold/chrome

144102187 bronzą/bronze

90 €

100 €

153 €



144102097 !

! Išpardavimas,
prekių kiekis ribotas.
Till sold out.

Lentyna rankšluosčiams

Towel holder with rail

665×120×225 mm

144302092 chromas/chrome

144202098 auksas/chromas, gold/chrome

144102097 bronzas/bronze

109 €

130 €

127 €



Dviguba lentyna rankšluosčiams

● Double Towel holder with rail

665×165×225 mm

144302252 chromas/chrome

144202258 auksas/chromas, gold/chrome

144102257 bronzas/bronze

99 €

115 €

172 €

! Išpardavimas, prekių kiekis ribotas.
● Till sold out.



Dvigubas rankšluosčių laikiklis

Double towel holder

665×125×115 mm

144304232 chromas/chrome

144204238 auksas/chromas, gold/chrome

144104237 bronzas/bronze

87 €

83 €

120 €



Stiklinė lentynėlė

Glass shelf

600×87×120 mm

144302242 chromas/chrome

144202248 auksas/chromas, gold/chrome

144102247 bronzas/bronze

68 €

82 €

105 €



Stiklinė lentynėlė

Glass shelf with tiltable rail

600×90×125 mm

144302262 chromas/chrome

144202268 auksas/chromas, gold/chrome

144102267 bronzas/bronze

73 €

90 €

124 €



Dviguba stiklinė lentynėlė

Double glass shelf

400×420×120 mm

144301122 chromas/chrome

144202128 auksas/chromas, gold/chrome

144102127 bronzas/bronze

138 €

148 €

247 €



Kosmetinis veidrodis pakabinamas, bronzas

Cosmetic mirror, bronze

184×200×412 mm, ø 133 mm

106101697

85 €

Kosmetinis veidrodis pakabinamas, auksas

Cosmetic mirror, gold

184×200×412 mm, ø 133 mm

106101698

85 €



Nosinių dozatorius

Handkerchief dispenser

250×130×75 mm

102303022

57 €



Šiukšliadėžė, brozinė

Trashbasket, bronze

170×260×170 mm, 3 l

104315023

57 €

VISTA



Muilinė, juoda
Soap dish, free standing
110×30×70 mm
120108196-100

15 €



Muilinė, beige
Soap dish, free standing
110×30×70 mm
120108196-101

15 €



Muilinė, mėlyna
Soap dish, free standing
110×30×70 mm
120108196-102

15 €



Muilinė, balta
Soap dish, free standing
110×30×70 mm
120108196-104

15 €

Medžiaga
Material

polirezinas
polyresin



Dantų šepetėlių laikiklis, juodas
Toothbrush holder, free standing
72×110×72 mm
120111026-100

19 €



Dantų šepetėlių laikiklis, beige
Toothbrush holder, free standing
72×110×72 mm
120111026-101

19 €



Dantų šepetėlių laikiklis, mėlynas
Toothbrush holder, free standing
72×110×72 mm
120111026-102

19 €



Dantų šepetėlių laikiklis, baltas
Toothbrush holder, free standing
72×110×72 mm
120111026-104

19 €

Paviršius apdaila
Surface finish

skaidri
juoda
clear
black



Blizgus
Polished

skaidri
smėli apdaila
clear
beige



Blizgus
Polished

skaidri
mėlyna
clear
blue



Blizgus
Polished

skaidri
balta
clear
white



Blizgus
Polished



Muilo dozatorius, juodas
Soap dispenser, free standing
70×172×82 mm, 250 ml
120109016-100

27 €



Muilo dozatorius, beige
Soap dispenser, free standing
70×172×82 mm, 250 ml
120109016-101

27 €



Muilo dozatorius, mėlynas
Soap dispenser, free standing
70×172×82 mm, 250 ml
120109016-102

27 €



Muilo dozatorius, baltas
Soap dispenser, free standing
70×172×82 mm, 250 ml
120109016-104

27 €



WC šepetėlio laikiklis, juodas
Toilet standing brushed, free standing
100×370×100 mm
120113316-100

41 €



WC šepetėlio laikiklis, beige
Toilet standing brushed, free standing
100×370×100 mm
120113316-101

41 €



WC šepetėlio laikiklis, mėlynas
Toilet standing brushed, free standing
100×370×100 mm
120113316-102

41 €



WC šepetėlio laikiklis, baltas
Toilet standing brushed, free standing
100×370×100 mm
120113316-104

41 €

Rawell

RANKŠLUOSČIŲ DŽIOVINTUVŲ PRIEDAI/RADIATOR ACCESSORIES



Kabliukas magnetinis
Magnetic single robe hook
54×54×57 mm
104106182

25 €



Kabliukas magnetinis
Magnetic single robe hook
54×54×57 mm
104106182

25 €



Rankšluosčių laikiklis tvirtinamas ant džiovintuvo
Towel holder for radiator, polished
600×80×220 mm
134504232

40 €



Rankšluosčių laikiklis tvirtinamas ant džiovintuvo, baltas
Towel holder for radiator, white
600×80×220 mm
134504235

28 €

Medžiaga
Material

zavaris
brass

nerūdijantis
plienas
stainless
steel



Rankšluosčių laikiklis magnetinis
Magnetic towel holder
550×54×63 mm
104104282

63 €



Rankšluosčių laikiklis magnetinis
Magnetic towel holder
260×54×63 mm
104104262

52 €



Rankšluosčių laikiklis magnetinis
Magnetic towel holder
430×54×63 mm
104104272

55 €

Paviršiaus apdaila
Surface finish

chromas
chrome



Blizgus
Polished

komaksitas
comxit



baltas
lakas
white
lacquer



juodas
lakas
black
lacquer



Matinis
Matt



Kabliukas ant džiovintuvo
Radiator hook
170×55×70 mm
104506122

chromas/polished
baltas/white

17 €



Rankšluosčiu laikiklis su 4 kabliukais ant džiovintuvo, chromas
Radiator adjustable towel holder with hooks, polished
355×40×90 mm
134504222

42 €



Rankšluosčio laikiklis su 4 kabliukais ant džiovintuvo, baltas
Radiator adjustable towel holder with hooks, white
355×40×90 mm
134504225

42 €



Rankšluosčių laikiklis, blizgus
Radiator towel holder, polished
610×48×140 mm
101204161

56 €



Rankšluosčių laikiklis, baltas
Radiator towel holder, white
610×48×140 mm
101204164

31 €



Rankšluosčių laikiklis, baltas
Radiator double towel holder
590×75×150 mm
101604174

40 €



Rankšluosčių laikiklis ant džiovintuvo
Straight adjustable towel bar
600×40×90 mm
134504202

35 €



Rankšluosčių laikiklis ant džiovintuvo
Adjustable towel bar, for radiator
600×40×95 mm
134504212

39 €

ELEKTRINIAI RANKŠLUOSČIŲ DŽIOVINTUVAI

HEATED TOWEL RAILS



Elektrinis rankšluosčių džiovintuvas, juodas

Heated towel rail, black
450×960×110 mm, 130 W
704151040

245 €



Elektrinis rankšluosčių džiovintuvas, chromas

Heated towel rail, polished
450×960×110 mm, 130 W
704151041

263 €



Elektrinis rankšluosčių džiovintuvas, baltas

Heated towel rail, white
450×960×110 mm, 130 W
704151044

245 €



Elektrinis rankšluosčių džiovintuvas, juodas

Heated towel rail, black
450×1 320×110 mm, 180 W
704151050

318 €



Elektrinis rankšluosčių džiovintuvas, chromas

Heated towel rail, polished
450×1 320×110 mm, 180 W
704151051

344 €



Elektrinis rankšluosčių džiovintuvas, baltas

Heated towel rail, white
450×1 320×110 mm, 180 W
704151054

344 €



Elektrinis rankšluosčių džiovintuvas, juodas

Heated towel rail, black
600×1 680×110 mm, 285 W
704151060

387 €



Elektrinis rankšluosčių džiovintuvas, chromas

Heated towel rail, polished
600×1 680×110 mm, 285 W
704151061

415 €



Elektrinis rankšluosčių džiovintuvas, baltas

Heated towel rail, white
600×1 680×110 mm, 285 W
704151064

387 €



Elektrinis rankšluosčių džiovintuvas, juodas

Heated towel rail, rod, black
124×1 720×155 mm, 46 W
704151000

189 €



Elektrinis rankšluosčių džiovintuvas, chromas

Heated towel rail, rod, polished
124×1 720×155 mm, 46 W
704151001

186 €



Elektrinis rankšluosčių džiovintuvas, baltas

Heated towel rail, rod, white
124×1 720×155 mm, 46 W
704151004

189 €

CYTRO



Medžiaga
Material

zavaris
brass

nerūdijantis
plienas
stainless
steel

plastmasinis
plastic

Paviršiaus apdaila
Surface finish

chromas
chrome

Blizgus
Polished

Šukuotas
Brushed

juoda
lakas
black
lacquer

Matinis
Matt

Lentynėlė montuojama tarp plytelių

Shower shelf

300×2×135 mm

101302401 blizgus/polished

101302405 matinis/brushed

101302400 juoda/black

70 €

70 €

70 €

Lentynėlė montuojama tarp plytelių

Shower shelf

297×2×210 mm

101302421 blizgus/polished

101302425 matinis/brushed

101302420 juoda/black

70 €

70 €

70 €

Lentynėlė montuojama tarp plytelių

Shower shelf

297×2×210 mm

101302441 blizgus/polished

101302445 matinis/brushed

101302440 juoda/black

70 €

70 €

70 €



Lentynėlė montuojama tarp plytelių

Shower shelf

300×15×135 mm

101302411 blizgus/polished

101302415 matinis/brushed

101302410 juoda/black

75 €

75 €

75 €

Lentynėlė montuojama tarp plytelių

Shower shelf

297×2×210 mm

101302431 blizgus/polished

101302435 matinis/brushed

101302430 juoda/black

75 €

75 €

75 €

Lentynėlė montuojama tarp plytelių

Shower shelf

297×2×210 mm

101302451 blizgus/polished

101302455 matinis/brushed

101302450 juoda/black

75 €

75 €

75 €



Dušo lentynėlė kampinė

Corner shower shelf

260×80×200 mm

146208072

77 €

340×80×250 mm

146208082

70 €

Dušo lentynėlė kampinė

Corner shower shelf

285×75×210 mm

146208092

84 €

Dušo lentynėlė

Corner shower shelf

250×70×105 mm

146208052

72 €

Dušo lentynėlė

Corner shower shelf

400×75×110 mm

146208062

99 €

! Išpardavimas, prekių kiekis ribotas.
• Till sold out.



Dušo lentynėlė

Shower shelf with squeegee

225×63×115 mm

102208302

Dušo lentynėlė

Shower shelf with squeegee

223×65×105 mm

102208292

76 €

106 €



Dušo lentynėlė - krepšelis, kabinaamas ant maišytuvo

Hang wire basket for tap

250×455×132 mm

153308332

64 €

Dušo lentynėlė kampinė

Corner shower shelf

280×75×160 mm

102208272

65 €

Dušo lentynėlė kampinė

Corner shower shelf

280×75×160 mm

102208282

89 €

Dušo lentynėlė kampinė

Corner shower shelf

311×45×210 mm

102308061

61 €

**Dušo lentynélé**

Shower shelf

300×26×115 mm

102308081

50 €

**Dušo lentynélé**

Shower shelf

300×26×115 mm

102308080

57 €

**Dušo lentynélé kampiné**

Shower shelf

205×25×110 mm

102308051

27 €

262×35×142 mm

102308261

33 €

**Dušo lentynélé kampiné**

Corner shower shelf

340×65×205 mm

146208192

80 €

**Dušo lentynélé kampiné**

Corner shower shelf

335×65×250 mm

146208212

86 €

**Dušo lentynélé kampiné**

Corner shower shelf

305×55×220 mm

146208016

48 €

**Dušo lentynélé**

Shower shelf

300×55×125 mm

146208036

44 €

**Dušo lentynélé**

Shower shelf

250×75×110 mm

146208406

64 €

**Dušo lentynélé kampiné**

Corner shower shelf

260×75×195 mm

146208376

64 €

**Dušo lentynélé**

Shower shelf

250×70×110 mm

146208396

64 €

**Dušo lentynélé kampiné**

Corner shower shelf

260×75×195 mm

146208386

64 €

**Dušo lentynélé kampiné**

Corner shower shelf

315×67×235 mm

102308216

54 €

**Dušo lentynélé**

Shower shelf

279×65×139 mm

102308226

48 €

**Dušo lentynélé kampiné**

Corner shower shelf

290×47×220 mm

153102390

38 €

**Dušo lentynélé**

Shower shelf

320×60×130 mm

146208112

43 €

235×58×130 mm

146208122

37 €

**Dušo lentynélé**

Shower shelf

320×110×135 mm

146208142

48 €

230×110×135 mm

146208152

41 €

**Dušo lentynélé**

Shower shelf

155×25×100 mm

146208132

26 €



Dušo lentynėlė - krepšelis

Shower shelf

405×70×120 mm

146208252

53 €



Dušo lentynėlė - krepšelis

Shower shelf

305×90×145 mm

146208262

45 €



Dušo lentynėlė - krepšelis

Shower shelf

305×70×125 mm

146208272

43 €



Dušo lentynėlė - krepšelis

Shower shelf

305×40×145 mm

146208282

39 €



Dušo lentynėlė - krepšelis

Shower shelf

250×70×112 mm

146208172

62 €



Dušo lentynėlė - krepšelis

Shower shelf

250×75×110 mm

146208362

60 €

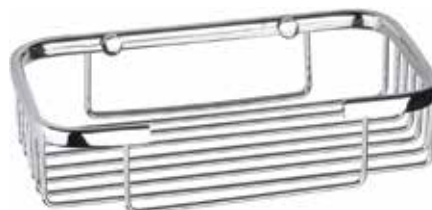

Dušo lentynėlė - krepšelis

Shower shelf

210×50×120 mm

146208292

50 €



Muilinė stačiakampė

Soap dish

130×30×90 mm

146208302

22 €



Dušo lentynėlė - krepšelis kampinis

Corner shower shelf

300×80×230 mm

146208312

43 €



Dušo lentynėlė - krepšelis kampinis

Corner shower shelf

265×40×205 mm

146208322

39 €

104308172

matinis/brushed



104308175

blizgus/polished



Dušo lentynėlė kampinė

Corner shower shelf

230×30×130 mm

104308172

32 €

104308175

28 €



Dviguba dušo lentynėlė - krepšelis

Hang double shower shelf

170×700×260 mm

104702172

113 €



Dušo lentynėlė - krepšelis kampinis

Corner shower shelf

300×80×230 mm

146208332

59 €

Dušo lentynėlė - krepšelis kampinis

Corner shower shelf

260×70×185 mm

146208352

66 €



Dušo lentynėlė kampinė

Corner shower shelf

173×30×111 mm

106308172

28 €



Dušo lentynėlė - krepšelis kampinis

Corner shower shelf

245×60×150 mm

102308122

35 €

Dušo lentynėlė - krepšelis kampinis juodas

Corner shower shelf

245×60×150 mm

102308120

43 €

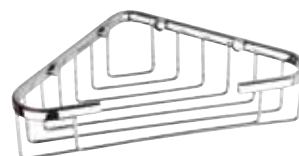

Dušo lentynėlė - krepšelis kampinis

Corner shower shelf

250×60×155 mm

146208342

30 €

146102272
blizgus/polished



146102275
matinis/brushed



Dušo lentynėlė

Shower shelf
270×40×110 mm
146102272
146102275

68 €
68 €

Dušo lentynėlė - krepšelis juodas

Shower shelf
230×30×100 mm
102308070

46 €



Dušo lentynėlė - krepšelis

Shower shelf, brushed
232×30×122 mm
104308072

33 €



Dušo lentynėlė - krepšelis

Shower shelf
230×30×100 mm
102308072

33 €



Dušo lentynėlė - krepšelis

Shower shelf
300×30×130 mm
102308082

38 €



Dušo lentynėlė

Shower shelf
200×30×115 mm
102308112

33 €



Muilinė pastatoma

Soap dish, free standing
95×30×75 mm
104708182

12 €

Dviguba dušo lentynėlė

Double shower shelf
220×230×116 mm
146208182

84 €

Dviguba dušo lentynėlė

Double shower shelf
305×380×115 mm
102308241

133 €



Dviguba dušo lentynėlė - krepšelis

Hang double shower shelf
250×705×205 mm
146208422

144 €



Dušo lentynėlė - krepšelis

Hang shower shelf
250×455×160 mm
146208432

88 €



Dviguba dušo lentynėlė kampinė

Double corner shower shelf
355×375×240 mm
146208222

176 €



Dviguba dušo lentynėlė kampinė

Double corner shower shelf
340×365×205 mm
146208202

149 €



Dviguba dušo lentynėlė - krepšelis kampinis

Double corner shower shelf
260×325×155 mm
102308132

74 €



Dviguba dušo lentynėlė - krepšelis kampinis

Double corner shower shelf
220×500×205 mm
146208232

109 €



Dviguba dušo lentynėlė - krepšelis kampinis

Double shower shelf
275×485×155 mm
146208242

103 €

KOSMETINIAI VEIDRODŽIAI

BATHROOM MIRRORS

Medžiaga
Material

zavaris
brass

nerūdijantis
pilnas
stainless
steel

plastmasinis
plastic

veidrodis
mirror

Paviršiaus apdaila
Surface finish

chrom
chrome

Blizgus
Polished

Šukuotas
Brushed



Kosmetinis veidrodis pakabinamas su LED apšvietimu

Cosmetic mirror with LED lighting

240×240×390 mm, ø 240 mm

116401772

230 €



Kosmetinis veidrodis su LED apšvietimu

Cosmetic mirror with 2x LED lighting

220×200×370 mm, ø 200 mm

116301142

191 €



Kosmetinis veidrodis su LED apšvietimu

Cosmetic mirror with 2x LED lighting

335×200×280 mm, ø 200 mm

116201772

211 €



Kosmetinis veidrodis su LED apšvietimu pakabinamas

Cosmetic mirror with LED lighting

225×200×365 mm, ø 200 mm

116101770

191 €



Kosmetinis veidrodis su LED apšvietimu

Cosmetic mirror with 2x LED lighting

230×210×400 mm, ø 210 mm

116101802

211 €



Kosmetinis veidrodis su LED apšvietimu

Cosmetic mirror with 2x LED lighting

225×200×365 mm, ø 200 mm

116101772

191 €



Kosmetinis veidrodis su LED apšvietimu

Cosmetic mirror with 2x LED lighting

216×216×370 mm, ø 160 mm

112101149

204 €

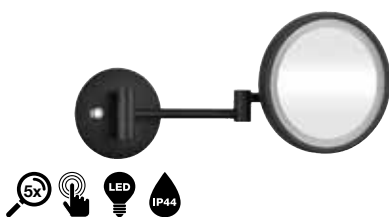

Kosmetinis veidrodis su LED apšvietimu, juodas

Cosmetic mirror with 3x LED lighting

255×200×400 mm, ø 200 mm

112101140

216 €



Kosmetinis veidrodis pakabinamas su LED apšvietimu, baltas

Cosmetic mirror with 2x LED lighting

255×200×400 mm, ø 200 mm

112101144

216 €



Kosmetinis veidrodis pakabinamas su LED apšvietimu

Cosmetic bath mirror with LED lighting

220×200×365 mm, ø 200 mm

116101142

191 €

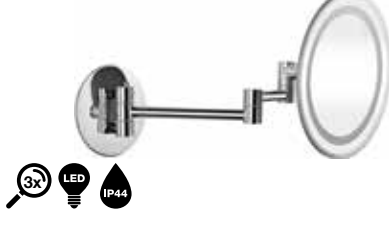

Kosmetinis veidrodis pakabinamas su LED apšvietimu

Cosmetic mirror with 2x LED lighting, plastic cover

260×230×425 mm, ø 225 mm

116301802

205 €



Kosmetinis veidrodis klijuojamas

Glue-on mirror

151×17×151 mm, ø 151 mm

112101150

50 €



Kosmetinis veidrodis pakabinamas

Double-sided cosmetic mirror

180×250×360 mm, ø 140 mm

106301705

85 €

šifuotas paviršius/brushed surface



Kosmetinis veidrodis pakabinamas

Double-sided cosmetic mirror

180×250×360 mm, ø 140 mm

106101697

85 €

bronzinis paviršius/bronze surface



Kosmetinis veidrodis pakabinamas

Double-sided cosmetic mirror

180×250×360 mm, ø 140 mm

106101698

85 €

auksinis paviršius/gold surface



Kosmetinis veidrodis pakabinamas

Double-sided cosmetic mirror

185×260×420 mm, ø 140 mm

106301122

38 €



Kosmetinis veidrodis pakabinamas
Double-sided cosmetic mirror
230×300×430 mm, ø 200 mm
172201512 46 €



Kosmetinis veidrodis pakabinamas
Double-sided cosmetic mirror
230×280×345 mm, ø 200 mm
172201522 44 €



Kosmetinis veidrodis pakabinamas
Double-sided cosmetic mirror
230×280×430 mm, ø 180 mm
112201512 75 €



Kosmetinis veidrodis pakabinamas juodas
Double-sided cosmetic mirror
230×280×430 mm, ø 180 mm
112201510 96 €



Kosmetinis veidrodis pakabinamas baltas
Double-sided cosmetic mirror
230×280×430 mm, ø 180 mm
112201514 96 €



Kosmetinis veidrodis
Cosmetic mirror, plastic cover
215×215×418 mm, ø 203 mm
116301522 126 €



Kosmetinis veidrodis pakabinamas
Cosmetic mirror
200×240×117 mm, ø 200 mm
112201332 57 €



Kosmetinis veidrodis pakabinamas
Cosmetic mirror with 360° joint
200×240×130 mm, ø 200 mm
116201332 52 €



Kosmetinis veidrodis pakabinamas
Double-sided cosmetic mirror
238×255×465 mm, ø 182 mm
112201518 90 €



Kosmetinis veidrodis pakabinamas
Cosmetic mirror
140×140×80 mm, ø 140 mm
112101121 45 €



Kosmetinis veidrodis pakabinamas
Cosmetic mirror
140×140×200 mm, ø 140 mm
112101521 58 €



Kosmetinis veidrodis pakabinamas
Double-sided cosmetic mirror
232×265×365 mm, ø 180 mm
112201522 64 €



Kosmetinis veidrodis su LED apšvietimu pakabinamas
Cosmetic mirror with LED lighting
240×200×410 mm
116101202 243 €



Kosmetinis veidrodis pakabinamas su LED apšvietimu
Cosmetic mirror with LED lighting
325×200×310 mm
116201202 250 €



Kosmetinis veidrodis su LED apšvietimu pakabinamas
Cosmetic mirror with 2× LED lighting, plastic cover
280×225×470 mm
116301812 218 €



Kosmetinis veidrodis su LED apšvietimu pakabinamas
Cosmetic mirror with 2× LED lighting
205×205×400 mm
112101202 45 €



Kosmetinis veidrodis su LED apšvietimu pakabinamas
Cosmetic mirror with LED lighting
260×200×290 mm
112102672 45 €

! Išpardavimas, prekių kiekis ribotas.
• Till sold out.

! Išpardavimas, prekių kiekis ribotas.
• Till sold out.



3x

Kosmetinis veidrodis pakabinamas

Cosmetic mirror, plastic cover

215×215×462 mm, ø 203 mm

116301212

126 €



3x

Kosmetinis veidrodis pakabinamas

Cosmetic mirror

130×240×100 mm

112201222

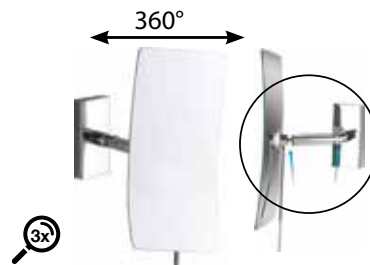

3x

Kosmetinis veidrodis pakabinamas

Cosmetic mirror with 360° joint

130×245×130 mm

116201222

57 €

52 €



1x + 3x

Kosmetinis veidrodis pakabinamas

Double-sided cosmetic mirror

195×320×390 mm

153301612

76 €



3x LED IP44

Kosmetinis veidrodis pakabinamas su LED apšvietimu

Cosmetic mirror on a pole with 2x LED lighting

200×575×155 mm, ø 200 mm

116501682

211 €



3x

Kosmetinis veidrodis pakabinamas

Cosmetic mirror on a pole

200×515×120 mm, ø 200 mm

116201792

84 €



3x

Kosmetinis veidrodis pakabinamas

Cosmetic mirror on a pole

200×535×140 mm, ø 200 mm

112201172

114 €



3x LED IP44

Kosmetinis veidrodis pakabinamas su LED apšvietimu

Cosmetic mirror on a pole with 2x LED lighting

200×550×155 mm

116501672

250 €



3x

Kosmetinis veidrodis, pastatomas

Cosmetic bath mirror free standing, plastic cover

215×375×145 mm

116401312

75 €



3x

Kosmetinis veidrodis pastatomas

Cosmetic mirror rectangular single side, free standing

130×300×190 mm

116201312

52 €



3x

Kosmetinis veidrodis pastatomas

Cosmetic mirror rectangular single side, free standing

200×300×190 mm, ø 200 mm

116201252

52 €



3x

Kosmetinis veidrodis, pastatomas

Cosmetic bath mirror free standing, plastic cover

215×375×145 mm, ø 215 mm

116401412

75 €



3x

Kosmetinis veidrodis pastatomas

Cosmetic standing mirror, plastic cover

130×300×190 mm

116201310

62 €



1x + 3x

Kosmetinis veidrodis, pastatomas

Cosmetic standing mirror

230×390×150 mm, ø 180 mm

112201412

56 €



1x + 3x

Kosmetinis veidrodis, pastatomas

Cosmetic standing mirror

235×385×150 mm, ø 200 mm

112201252

62 €



Veidrodis su LED apšvietimu, prisilietimo jutikliu

Mirror with LED lighting, touch sensor

600×800×39 mm, 4,99 W

101201107

248 €



Veidrodis su LED apšvietimu, prisilietimo jutikliu

Mirror with LED lighting, touch sensor

600×800×39 mm, 4,99 W

101301107

299 €



Veidrodis su LED apšvietimu, prisilietimo jutikliu

Mirror with LED lighting, touch sensor

600×800×39 mm, 4,99 W

101401107

319 €



Veidrodis su LED apšvietimu, prisilietimo jutikliu

Mirror with LED lighting, touch sensor

800×600×39 mm, 4,99 W

101201117

249 €



Veidrodis su LED apšvietimu, prisilietimo jutikliu

Mirror with LED lighting, touch sensor

800×600×39 mm, 4,99 W

101301117

292 €



Veidrodis su LED apšvietimu, prisilietimo jutikliu

Mirror with LED lighting, touch sensor

800×600×39 mm, 4,99 W

101401117

334 €



Veidrodis su LED apšvietimu, prisilietimo jutikliu

Mirror with LED lighting, touch sensor

800×800×39 mm, 4,99 W

101201127

266 €



Veidrodis su LED apšvietimu, prisilietimo jutikliu

Mirror with LED lighting, touch sensor

800×800×39 mm, 4,99 W

101301127

306 €



Veidrodis su LED apšvietimu, prisilietimo jutikliu

Mirror with LED lighting, touch sensor

800×800×39 mm, 4,99 W

101401127

344 €



Veidrodis su LED apšvietimu, prisilietimo jutikliu

Mirror with LED lighting, touch sensor

1000×600×39 mm, 4,99 W

101201137

284 €



Veidrodis su LED apšvietimu, prisilietimo jutikliu

Mirror with LED lighting, touch sensor

1000×600×39 mm, 4,99 W

101301137

316 €



Veidrodis su LED apšvietimu, prisilietimo jutikliu

Mirror with LED lighting, touch sensor

1000×600×39 mm, 4,99 W

101401137

356 €



Veidrodis su LED apšvietimu, prisilietimo jutikliu

Mirror with LED lighting, touch sensor

1000×800×39 mm, 4,99 W

101201147

356 €



Veidrodis su LED apšvietimu, prisilietimo jutikliu

Mirror with LED lighting, touch sensor

1000×800×39 mm, 4,99 W

101301147

324 €



Veidrodis su LED apšvietimu, prisilietimo jutikliu

Mirror with LED lighting, touch sensor

1000×800×39 mm, 4,99 W

101401147

381 €



Veidrodis su LED apšvietimu, prisilietimo jutikliu

Mirror with LED lighting, touch sensor

1200×600×39 mm, 4,99 W

101201157

380 €



Veidrodis su LED apšvietimu, prisilietimo jutikliu

Mirror with LED lighting, touch sensor

1200×600×39 mm, 4,99 W

101301157

390 €



Veidrodis su LED apšvietimu, prisilietimo jutikliu

Mirror with LED lighting, touch sensor

1200×600×39 mm, 4,99 W

101401157

406 €



Veidrodis su LED apšvietimu

Mirror with LED lighting

600×800×35 mm, 6 W

127101809

424 €

! Išpardavimas, prekių kiekis ribotas.
• Till sold out.

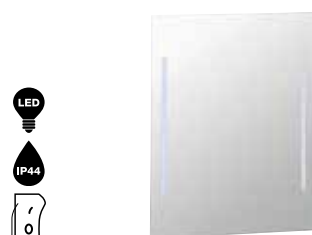

Veidrodis su LED apšvietimu

Mirror with LED lighting

600×800×35 mm, 3 W

127201659

247 €

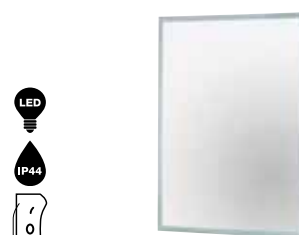

Veidrodis su LED apšvietimu

Mirror with LED lighting

600×800×35 mm, 8 W

127201679

306 €

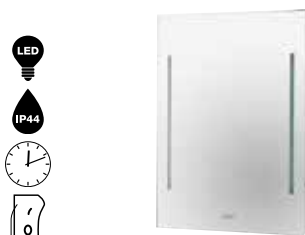

Veidrodis su LED apšvietimu ir laikrodžiu

Mirror with LED lighting and clock

600×800×50 mm, 3 W

127201669

306 €

! Išpardavimas, prekių kiekis ribotas.
• Till sold out.



Veidrodis su LED apšvietimu, prisilietimo jutikliu

Mirror with LED lighting, touch sensor

1000×600×35 mm, 6 W

127101059

476 €

! Išpardavimas, prekių kiekis ribotas.
• Till sold out.



Veidrodis su LED apšvietimu

Mirror with LED lighting

900×600×30 mm, 3 W

128201869

457 €

! Išpardavimas, prekių kiekis ribotas.
• Till sold out.



Veidrodis su LED apšvietimu, prisilietimo jutikliu

Mirror with LED lighting, touch sensor

1200×600×35 mm, 8 W

127201719

357 €

! Išpardavimas, prekių kiekis ribotas.
• Till sold out.

VIEŠOSIOS ERDVĖS

PUBLIC SPACES



Automatinis dozatorius dezinfekciniam skysčiui su stovu

Automatic dispenser for disinfection with a stand
300×1215×300 mm, 1100 ml
124109346 133 €



Automatinis dozatorius dezinfekciniam skysčiui su stovu, nerūdijantis plienas

Automatic dispenser for disinfection with a stand, stainless steel
350×1230×350 mm, 1200 ml
124109355 264 €



Automatinis dozatorius, plastikas

Automatic dispenser, plastic
140×235×107 mm, 1100 ml
124109347 muilas/soap
124109334 dezinfekcija/disinfectant
65 €



Automatinis dozatorius, nerūdijantis plienas

Automatic dispenser, stainless steel, brushed
140×235×102 mm, 1200 ml
124109265 muilas/soap
124109335 dezinfekcija/disinfectant
126 €



Automatinis dozatorius, plastikas

Automatic dispenser, plastic
140×235×102 mm, 1200 ml
124109290 muilas/soap
124109330 dezinfekcija/disinfectant
57 €



Automatinis muilo putų dozatorius, baltas plastikas

Automatic foam soap dispenser, white plastic
135×275×120 mm, 1000 ml
121209032 117 €



Automatinis dozatorius dezinfekciniam geliui arba muilui

Automatic soap or disinfectant gel, stainless steel, brushed
142×268×102 mm, 1100 ml
105109335 183 €



Automatinis dozatorius putoms

Automatic foam dispenser, stainless steel, brushed
142×268×102 mm, 1100 ml
105109345 193 €



Muilo dozatorius, nerūdijantis plienas

Soap dispenser, stainless steel
70×175×120 mm, 250 ml
137209155 92 €



Muilo dozatorius, plastikas

Soap dispenser, plastic
86×165×115 mm, 450 ml
107109240 27 €



Muilo dozatorius, nerūdijantis plienas

Soap dispenser, stainless steel, brushed
86×160×105 mm, 450 ml
107109256 18 €

Automatinis muilo dozatorius, nerūdijančio plieno, matinis

Touch-free soap dispenser automatic
100×220×113, 700 ml
141109195 133 €



Dvigubas muilo dozatorius, nerūdijančio plieno/plastikas

Soap dispenser, stainless steel/plastic
136×212×72 mm, 2×250 ml
152109381 89 €



Trigubas muilo dozatorius, nerūdijančio plieno/plastikas

Soap dispenser, stainless steel/plastic
205×212×72 mm, 3×250 ml
152109391 2 592 €



Muilo dozatorius

Lever dispenser for liquid soap, stainless steel
100×335×195 mm, 1000 ml
101109285 32 €

Muilo dozatorius, nerūdijančio plieno/plastikas

Soap dispenser, stainless steel/plastic
110×212×72 mm, 250 ml
152109371 71 €

Medžiaga Material
Zalvaris Brass
nerūdijantis plienas stainless steel
plastmasinis plastic
veidrodis mirror

Paviršiaus apdaila Surface finish

chromas chrome

Blizgus Polished

Šukuotas Brushed

baltas lakas white lacquer

juodas lakas black lacquer

Matinis Matt



Muilo dozatorius, nerūdijančio plieno, juodas

Soap dispenser, stainless steel, black

100×320×110 mm, 1 100 ml

105109410

63 €



Muilo dozatorius, nerūdijančio plieno, blizgus

Soap dispenser, stainless steel, polished

100×320×110 mm, 1 100 ml

105109411

63 €



Muilo dozatorius, nerūdijančio plieno, matinis

Soap dispenser, stainless steel, brushed

100×320×110 mm, 1 100 ml

105109415

63 €



Muilo dozatorius, nerūdijančio plieno, matinis

Soap dispenser, stainless steel, brushed

125×240×100, 350 ml

151109015

63 €



Muilo dozatorius, plastikas

Soap dispenser, plastic

115×245×110 mm, 1000 ml

121209037

skystas muilas/liquid soap

46 €

121209407

muilo putoms/foam soap

44 €



Muilo dozatorius, plastikas

Dispenser, plastic

115×245×110 mm, 1000 ml

121209030

skystas muilas/liquid soap

42 €

121209400

muilo putoms/foam soap

44 €



Muilo dozatorius, plastikas

Dispenser, plastic

115×245×110 mm, 1000 ml

121109036

skystas muilas/liquid soap

42 €

121109406

muilo putoms/foam soap

40 €



Muilo dozatorius, chromuotas plastikas

Soap dispenser, chromed plast

125×240×100 mm, 500 ml

151109095

35 €



Muilo dozatorius, plastikas

Soap dispenser, plastic

65×185×75 mm, 300 ml

121209142

blizgus/polished

121209145

matinis/matt

28 €



Muilo dozatorius, plastikas, baltas

Soap dispenser, plastic, white

65×185×75 mm, 300 ml

121209144

24 €



Muilo dozatorius, plastikas, juodas

Soap dispenser, plastic, black

65×185×75 mm, 300 ml

121209140

26 €



Dvigubas muilo dozatorius, plastikas

Double soap dispenser, plastic

120×185×75 mm, 2×300 ml

121209132

blizgus/polished

121209135

matinis/matt

44 €



Muilo dozatorius, nerūdijančio plieno, matinis

Soap dispenser, stainless steel

110×240×85 mm, 800 ml

106109085

60 €



Muilo dozatorius, nerūdijančio plieno, matinis

Soap dispenser, stainless steel brushed

97×150×93 mm, 500 ml

105109025

39 €



Muilo dozatorius, nerūdijančio plieno, juodas

Soap dispenser, stainless steel brushed

97×150×93 mm, 500 ml

105109020

57 €



Muilo dozatorius, nerūdijančio plieno, blizgus

Soap dispenser, stainless steel, polished

100×150×105 mm, 500 ml

106109091

36 €



Muilo dozatorius, nerūdijančio plieno, matinis

Soap dispenser, stainless steel brushed

107×180×98 mm, 850 ml

105109035

42 €



Muilo dozatorius, nerūdijančio plieno, matinis

Soap dispenser, stainless steel, brushed

125×210×110 mm, 1250 ml

105109075

49 €



Muilo dozatorius, nerūdijančio plieno, matinis

Soap dispenser, stainless steel, brushed

180×180×105 mm, 1500 ml

105109205

65 €



Integruojamas muilo dozatorius, nerūdijančio plieno

Integrated soap dispenser, stainless steel

240×140×150 mm, 1100 ml

105109015

134 €



Laikiklis muilo dozatoriui, apvalus

Holder for soap dispenser, round

90×175×70, 500 ml

146109420 juodas/black

146109421 blizgus/polished

146109425 matinis/brushed

43 €

43 €

41 €



Dvigubas laikiklis muilo dozatoriui, apvalus

Double holder for soap dispenser, round

90×175×70, 500 ml

146109430 juodas/black

146109431 blizgus/polished

146109435 matinis/brushed

52 €

52 €

51 €



Trigubas laikiklis muilo dozatoriui, apvalus

Triple holder for soap dispenser, round

90×175×70, 500 ml

146109440 juodas/black

146109441 blizgus/polished

146109445 matinis/brushed

75 €

75 €

71 €



Plastikinis butelis su pompa muilo dozatoriui, apvalus

Plastic bottle with pump for soap dispenser, round

75×205×75, 500 ml

131567700 baltas/white

131567701 rudas/brown

131567702 juodas/black

3 €

3 €

3 €



Laikikliai ir buteliai derinami pagal kliento pasirinkimą.
Holders and bottles are combined according to the customer's choice.



Magnetinis raktas yra pakuotės dalis.
The magnetic key is part of packaging.

131567709

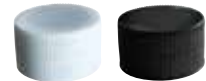

Butelio dangtelis muilo dozatoriui
Bottle cap for soap dispenser

30×17×30 mm

131567719 baltas/white

131567708 juodas/black

1 €



Laikiklis muilo dozatoriui, kvadratinis

Holder for soap dispenser, square

90×175×70, 500 ml

146109450 juodas/black

146109451 blizgus/polished

146109455 matinis/brushed

43 €

43 €

41 €



Dvigubas laikiklis muilo dozatoriui, kvadratinis

Double holder for soap dispenser, square

90×175×70, 500 ml

146109460 juodas/black

146109461 blizgus/polished

146109465 matinis/brushed

52 €

52 €

51 €



Trigubas muilo dozatoriaus laikiklis, kvadratinis

Triple holder for soap dispenser, square

90×175×70, 500 ml

146109470 juodas/black

146109471 blizgus/polished

146109475 matinis/brushed

75 €

75 €

71 €



Plastikinis butelis su pompa muilo dozatoriui, kvadratinis

Plastic bottle with pump for soap dispenser, square

75×205×75, 500 ml

131567703 baltas/white

131567704 rudas/brown

131567705 juodas/black

3 €

3 €

3 €



Integruojamas muilo dozatorius

Integrated soap dispenser, top filling,
62×287×125 mm, 470 ml

136109012	blizgus/polished	38 €
136109012	juodas/black	38 €



Integruojamas muilo dozatorius

Built-in soap/detergent dispenser,
top filling

55×270×125 mm, 300 ml

152109122	blizgus/polished	50 €
152109125	matinis/brushed	49 €

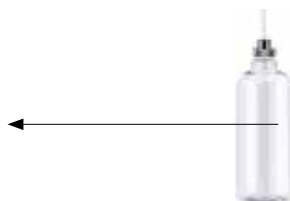

Talpa 1 l integruojamam dozatoriui

Container 1 l for 152109122,5

85×290×85 mm, 1 000 ml	40235	10 €
------------------------	-------	------



Integruojamas muilo dozatorius

Built-in soap and detergent dispenser,
top filling

55×270×125 mm, 1100 ml

152109142	blizgus/polished	50 €
152109143	matinis/brushed	57 €



Nosinių dozatorius, chromas, plastikas

Paper tissue dispenser, chrome/plastic

267×72×137 mm

101303001	60 €
-----------	------



Nosinių dozatorius, nerūdijančio plieno

Paper tissue dispenser, stainless steel

250×130×75 mm

102303020	juodas/black	47 €
102303021	blizgus/polished	39 €
102303025	matinis/brushed	73 €

250×130×70 mm

102303022	bronzos/bronze	57 €
-----------	----------------	------

Nosinių dozatorius

Paper tissue dispenser cube

120×130×120 mm

101003021	chromo plast/chrome, plastic	32 €
-----------	------------------------------	------

125×130×130 mm

105103071	nerūdijančio plieno/stainless	50 €
-----------	-------------------------------	------



Nosinių dozatorius nerūdijančio plieno

Paper tissue dispenser, stainless steel

300×160×60 mm

113103021	62 €
-----------	------

Integruojamas popierinių nosinių dėžutės laikiklis, blizgus

Integrated holder for Paper tissue dispenser, polished

200×120×110 mm

134203022	41 €
-----------	------

Higieninių maišelių laikiklis, plastikas

HygBag dispenser, plastic

100×135×25 mm

101403032	chromo plast/chrome, plastic	12 €
101403030	juoda plast/black, plastic	12 €

Higieninių maišelių laikiklis

HygBag for paper bag

120×240×32 mm

101403091	blizgus/polished	37 €
-----------	------------------	------

101403095
 matinis/brushed | 38 € |

101403094
 baltas/white | 30 € |

Higieninių maišelių laikiklis, nerūdijančio plieno

HygBag, stainless steel

92×131×24 mm

101403130	juoda/black	20 €
101403131	blizgus/polished	29 €
101403135	baltas/white	29 €
101403134	matinis/brushed	21 €

Higieninių maišelių laikiklis, nerūdijančio plieno

HygBag dispenser, plastic

95×145×30 mm

101403031	blizgus/polished	46 €
101403035	matinis/brushed	46 €

Popierinių rankšluosčių dozatorius „Autocut“, plastikas

Paper towel dispenser „Autocut“, 410 mm, plastic, white

300×410×230 mm

121103116	208 €
-----------	-------

Popierinių rankšluosčių dozatorius, nerūdijančio plieno

Hand towel dispenser, stainless steel

280×245×105 mm

113103030	juoda/black	76 €
113103031	blizgus/polished	49 €
113103035	matinis/brushed	49 €

Popierinių rankšluosčių dozatorius, nerūdijančio plieno

Hand towel dispenser, stainless steel

280×245×105 mm

113103040	juoda/black	96 €
113103041	blizgus/polished	64 €
113103045	matinis/brushed	64 €

64



Popierinių rankšluosčių dozatorius, baltas plastikas

Paper towel dispenser, white plastic

260×315×105 mm

121103014

32 €

Popierinių rankšluosčių dozatorius, baltas plastikas

V-folded paper towel dispenser, white plastic

260×380×160 mm

121103106

42 €

WC sėdynės užtiesalų dozatorius, plastikas

Toilet seat cover dispenser

435×285×50 mm

121103126 baltas/white

19 €

Jumbo-roll WC popieriaus dozatorius, plastikas

Jumbo-roll Toilet Dispenser, white plastic

270×285×130 mm

121112056

34 €



Jumbo-roll WC popieriaus dozatorius, nerūdijančio plieno

Jumbo-roll toilet paper dispenser, stainless steel

200×210×130 mm

148112050 juodas/black

53 €

148112051 blizgus/polished

40 €

148112055 matinis/brushed

40 €



Jumbo-roll WC popieriaus dozatorius, nerūdijančio plieno

Jumbo-roll toilet paper dispenser, stainless steel

260×282×117 mm

148212050 juodas/black

77 €

148212051 blizgus/polished

54 €

148212055 matinis/brushed

54 €



Jumbo-roll WC popieriaus dozatorius, nerūdijančio plieno

Jumbo-roll toilet paper dispenser, stainless steel

310×325×128 mm

148312080 juodas/black

108 €

148312081 blizgus/polished

69 €

148312085 matinis/brushed

69 €



WC popieriaus laikiklis su dangteliu/mobiliaus telefono lentynėle, plieno

Toilet paper holder with shelf, steel

90×175×70 mm

101012150 juodas/black

35 €

101012154 baltas/white

35 €



Dvigubas WC popieriaus laikiklis, nerūdijančio plieno

Double toilet paper holder, stainless steel

125×260×125 mm

104112200 juodas/black

60 €

104112201 blizgus/polished

65 €

104112205 matinis/brushed

58 €



WC popieriaus laikiklis su dangteliu/mobiliaus telefono lentynėle, blizgus

Toilet paper holder with cover/mobile phone shelf

135×55×103 mm

146212011

26 €



WC popieriaus laikiklis su dangteliu/mobiliaus telefono lentynėle, blizgus

Toilet paper holder with cover/mobile phone shelf, polished

180×77×93 mm

153312132

20 €



WC popieriaus laikiklis su dangteliu

Paper holder with cover

140×80/190×100 mm

105112315

23 €



Dvigubas WC popieriaus laikiklis, nerūdijančio plieno, matinis

Double paper holder, stainless steel, matt

320×30×90 mm

146212245

58 €



Dvigubas popieriaus laikiklis su dangteliais

Double paper holder with cover

270×140×107 mm

104112092

75 €



WC popieriaus laikiklis integruojamas, blizgus

Integrated holder for toilet paper, polished

200×60×100 mm

134103012

41 €



Durų stabdis sieninis, nerūdijančio plieno

Door stop on the wall, stainless steel
46×65×100 mm

346218121 blizgus/polished
346218125 matinis/brushed

13 €
8 €



Durų stabdis sieninis, nerūdijančio plieno

Door stop on the wall, stainless steel
50×95×50 mm

346218021 blizgus/polished
346218025 matinis/brushed

15 €
10 €



Durų stabdis grindinis, nerūdijančio plieno

Door stop on the wall, stainless steel
37×40×37 mm

346218211 blizgus/polished
346218215 matinis/brushed

15 €
12 €



Durų stabdis grindinis, nerūdijančio plieno

Door stop on the wall, stainless steel
35×40×35 mm

346218011 blizgus/polished
346218015 matinis/brushed

15 €
10 €



Durų stabdis grindinis, nerūdijančio plieno

Door stop on the wall, stainless steel
46×46×46 mm

346218111 blizgus/polished
346218115 matinis/brushed

10 €
6 €



Durų stabdis sieninis, nerūdijančio plieno

Door stop on wall, stainless steel
18×18×80 mm

101218022 blizgus/polished
101218025 matinis/brushed
101218027 žalvaris/brass
101218020 juoda/black

21 €
18 €
22 €
16 €



Durų stabdis grindinis, nerūdijančio plieno

Door stop on floor, stainless steel
33×30×33 mm

101218012 blizgus/polished
101218015 matinis/brushed
101218017 žalvaris/brass
101218010 juoda/black

15 €
14 €
20 €
16 €



Trigubas kabliukas, nerūdijančio plieno

Hanger with 3 hooks, swivel
220×30×40 mm

106105181

13 €



Skalbinių virvės laikiklis, nerūdijančio plieno

Skalbinių virvės laikiklis
ø 95×45 mm, l = 2600 mm

123126022

28 €



Stiklinė muilinė pakabinama

Glass soap dish
103×42×117 mm
135008025

27 €



Muilinė pastatoma

Soap dish, free standing
98×15×98 mm
139108342

48 €



Muilinė pastatoma

Soap dish, free standing
90×18×90 mm
139108192

44 €



Dviguba lenynėlė su ratukais, nerūdijantis plienas

Trolley
450×820×300 mm
104832012

270 €



Penkiagubas rankšluosčių laikiklis

Penta Towel holder, polished
150×265×120 mm
101302182

63 €



Butelių atidarytuvas, nerūdijančio plieno

Bottle opener, stainless steel, polished
45×65×40 mm
101832011

22 €



Peleninė, nerūdijančio plieno

Ash tray, polished
100×120×35 mm
106101015

15 €



Šiukšliadėžė, nerūdijančio plieno

Waste bin, stainless steel
225×305×162 mm, 6 l

- 126115390 auksas/gold
- 126115393 rozinis auksas/rose gold
- 126115395 šedį/gray
- 126115398 juodas/black

- 39 €
- 39 €
- 38 €
- 39 €

Šiukšliadėžė rūšivimui, nerūdijančio plieno

Waste sorted bin, stainless steel
250×315×250 mm, 15 l

- 126115380 juodas/black
- 126115385 matinis/brushed

- 46 €
- 53 €

Šiukšliadėžė rūšivimui, nerūdijančio plieno

Waste sorted bin, stainless steel
250×315×250 mm, 15 l

- 126115370 juodas/black
- 126115375 matinis/brushed

- 46 €
- 53 €



Šiukšliadėžė rūšivimui, nerūdijančio plieno

Recycling trash Can double, stainless steel brushed
404×492×321 mm, 15 l + 15 l

137115165

150 €

Šiukšliadėžė rūšivimui, nerūdijančio plieno

Waste sorting bin; stainless steel, brushed
590×435×375 mm, 3×14 l

104315262

108 €

Šiukšliadėžė rūšivimui, nerūdijančio plieno

Waste sorting bin; stainless steel, brushed
590×435×375 mm, 2×20 l

104315272

99 €

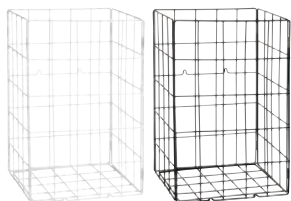

Šiukšliadėžė, nerūdijančio plieno

Wire basket, steel
350×550×265 mm

- 153115064 baltas/white
- 153115060 juodas/black

- 62 €
- 62 €

Stalinė šiukšliadėžė, nerūdijančio plieno

Table bin with cover, stainless steel brushed
120×155×120 mm, 1,5 l

137115205

30 €

Šiukšliadėžė, nerūdijančio plieno, matinė

Room bin, polished/matt
250×295×250 mm, 7,5 l

150115161

69 €

Šiukšliadėžė, nerūdijančio plieno, matinė

Waste bin stainless steel, brushed
255×310×255 mm, 7,5 l

150115191

36 €



Šiukšliadėžė, juoda

Room bin, black
250×295×250 mm, 7,5 l

150115151

43 €

Šiukšliadėžė nerūdijančio plieno, pakabinama

Wall mounted waste bin, stainless steel
170×235×240 mm, 3 l

125115051
125115055

30 €
30 €



Šiukšliadėžė, nerūdijančio plieno, blizgi

Pedal bin, stainless steel, polished
200×300×200 mm, 6 l

125115071

38 €

Šiukšliadėžė, nerūdijančio plieno, matinė

Waste bin without cover, stainless steel
240×340×240 mm, 9 l

137115225

84 €

Šiukšliadėžė

Trashbasket, bronze
170×260×170 mm, 3 l

104315023

57 €

Šiukšliadėžė, nerūdijančio plieno matinė

Open trash can, stainless steel brushed
450×755×430 mm, 90 l

137115215

293 €



Šiukšliadėžė nerūdijančio plieno, pakabinama

Waste bin wall mounted, stainless steel

190×265×90 mm, 5 l

105115055

68 €



Šiukšliadėžė nerūdijančio plieno, pakabinama

Square waste bin, wall mounted

205×300×100 mm, 6 l

101915051 blizgus/polished

101915054 baltas/white

101915055 matinis/brushed

101915050 juoda/black

83 €

68 €

75 €

63 €



Šiukšliadėžė be dangčio, nerūdijančio plieno

Waste bin without cover, stainless steel

200×270×200 mm, 9 l

115115031 blizgus/polished

115115035 matinis/brushed

35 €

35 €



Šiukšliadėžė

Waste bin

205×280×205 mm, 5 l

104315010 baltas/white

104315014 juoda/black

26 €

26 €



Šiukšliadėžė, nerūdijančio plieno

Pedal bin, stainless steel

blizgus/polished

104315022 170 × 255 × 170 mm, 3 l

104315012 200 × 280 × 200 mm, 5 l

104315032 250 × 390 × 250 mm, 12 l

104315082 300 × 450 × 300 mm, 20 l

104315092 300 × 650 × 300 mm, 30 l

104315102 350 × 650 × 350 mm, 40 l

matinis/brushed

104315025 170 × 255 × 170 mm, 3 l

104315052 200 × 280 × 200 mm, 5 l

20 €

25 €

41 €

83 €

100 €

139 €

19 €

32 €



Keturkampia šiukšliadėžė, pastatoma ar pakabinama, nerūdijančio plieno

Square waste bin, free standing or hanging, stainless steel

370×460×165 mm, 25 l

125115041

125115045

162 €

151 €



Šiukšliadėžė, nerūdijančio plieno

Wastebasket square, hanging

blizgus/polished

101915111 250 × 500 × 250 mm, 25 l

101915121 300 × 600 × 250 mm, 45 l

101915131 350 × 750 × 250 mm, 75 l

matinis/brushed

101915115 250 × 500 × 250 mm, 25 l

101915125 300 × 600 × 250 mm, 45 l

101915135 300 × 600 × 250 mm, 45 l

juoda/black

101915110 250 × 500 × 250 mm, 25 l

172 €

262 €

417 €

172 €

262 €

417 €

156 €



Lauko peleninė

Ashtray outdoor

298×800×298 mm

101015150

120 €



Popierinių rankšluosčių doratorius su šiukšliadėže, pakabinamas

Hand towel dispenser with garbage bin, polished, hanging

310×1225×155 mm

113103052 blizgus/polished

113103055 matinis/brushed

962 €

962 €



Automatinis rankų džiovintuvas, nerūdijančio plieno

Automatinisic hand dryer, stainless steel

290×325×105 mm, 1000 W

924224110 juoda/black	324 €
924224111 blizgus/polished	324 €
924224115 matinis/brushed	324 €

Automatinis rankų džiovintuvas, nerūdijančio plieno

Automatinisic hand dryer, stainless steel

173×255×150 mm, 1350 W

924224130 juoda/black	249 €
924224131 blizgus/polished	249 €
924224135 matinis/brushed	249 €

Automatinis rankų džiovintuvas, nerūdijančio plieno

Automatinisic hand dryer, stainless steel

295×320×162 mm, 1800 W

924224120	342 €
924224121	342 €
924224125	342 €



Automatinis rankų džiovintuvas, nerūdijančio plieno

Automatinisic hand dryer, stainless steel

260×230×195 mm, 2300 W

924224140 juoda/black	346 €
924224141 blizgus/polished	346 €
924224145 matinis/brushed	346 €

Automatinis rankų džiovintuvas, nerūdijančio plieno

Automatinisic hand dryer, stainless steel

170×255×100 mm, 700 W

924224150 juoda/black	208 €
924224155 matinis/brushed	208 €



Automatinis rankų džiovintuvas, nerūdijančio plieno

Automatinisic hand dryer, stainless steel

270×240×200 mm, 2500 W

945224061 blizgus/polished	431 €
106224015 matinis/brushed	419 €

Rankų džiovintuvas, baltas plastikas

Hand dryer, plastic white

240×240×230 mm, 1800 W

945224016	133 €
-----------	-------

Rankų džiovintuvas, HEPA filter, baltas plastikas

Hand dryer with HEPA filter, plastic, white color

298×669×184 mm, 1850 W

924224104	894 €
-----------	-------

Praustuvo laikiklis

Washbasin bracket

dešinė/right



kairė/left

Ilgis/Bracket		Pakuotėje 1 pora Package 1 pair	Svoris/Weight	
L = 300 mm	201541014		30 kg	61 €
L = 400 mm	201541024	30 kg	67 €	
L = 400 mm	201541034	50 kg	70 €	
L = 450 mm	201541044	50 kg	75 €	

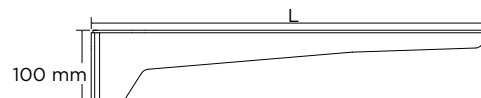

Praustuvo laikiklis, stačiakampis

Wash Basin Bracket rectangular

dešinė/right



kairė/left

	L			
Plienas blizgus/Stainless polished	490 mm	201541061	dešinė/right	93 €
Plienas blizgus/Stainless polished	490 mm	201541051	kairė/left	93 €
Plienas matinis/Stainless matt	490 mm	! 201541065	dešinė/right	70 €
Plienas matinis/Stainless matt	490 mm	! 201541055	kairė/left	70 €
Fe balta/Fe white	490 mm	201541064	dešinė/right	53 €
Fe balta/Fe white	490 mm	201541054	kairė/left	53 €
Fe juodas/Fe black	490 mm	201541060	dešinė/right	62 €
Fe juodas/Fe black	490 mm	201541050	kairė/left	62 €

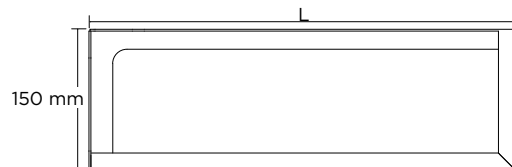

! Išpardavimas, prekių kiekis ribotas.
• Till sold out.



Plaukų džiovintuvas be laikiklio su jonizacija

Hairdryer without holder, ionic function

90×260×190 mm, 1 800 W

945533166 pilka/gray

945533168 juoda/black

71 €

64 €



Plaukų džiovintuvas su laikikliu ir maitinimo lizdu

Hairdryer with holder and socket

110×240×310 mm, 1 600 W

945533154 baltas/white - susuktas kabelis/twisted cable

945533158 juoda/black - susuktas kabelis/twisted cable

81 €

81 €

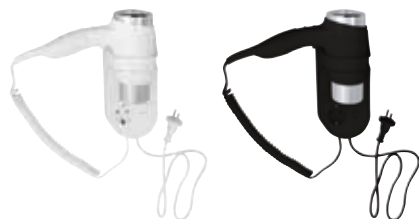

Plaukų džiovintuvas su laikikliu ir maitinimo lizdu

Hairdryer with holder and socket

110×240×310 mm, 1 400 W

945233054 baltas/white

945233058 juoda/black

81 €

81 €



Plaukų džiovintuvas su laikikliu

Hairdryer with holder

110×245×140 mm, 1 400 W

945533074

63 €



Plaukų džiovintuvas su laikikliu

Hairdryer with holder

110×240×310 mm, 1 400 W

945233066

70 €



Plaukų džiovintuvas su laikikliu

Hairdryer with holder

75×270×190 mm, 1 400 W

999433084 baltas/white - straight cable/twisted cable

999433084-2 baltas/white - susuktas kabelis/twisted cable

999433088 juoda/black - susuktas kabelis/twisted cable

78 €

78 €

78 €



Plaukų džiovintuvas be laikiklio

Hairdryer without holder

75×270×190 mm, 1 400 W

945433084 baltas/white

945433088 juoda/black

50 €

50 €



Plaukų džiovintuvo laikiklis

Hairdryer holder

80×55×100 mm

101117012

27 €



Plaukų džiovintuvas su laikikliu

Hotel Hairdryer

180×370×120 mm

945133016

118 €

Tekstilinis maišelis plaukų džiovintuvui

Hairdryer bag

250×320×10 mm

199100200

7 €



Plaukų džiovintuvo laikiklis

Hairdryer holder, spiral

105×118×123 mm

132117022 kvadratinis/square

100×130×125 mm

104117022 apvalus/round

34 €

30 €

**Atlenkiama dušo kėdutė, nerūdijančio plieno, plastiko**

Reversible shower seat, stainless steel

462×120×450 mm

347125010 juoda/black

347125011 matinis/brushed

289 €

286 €

**Atlenkiama dušo kėdutė su atrama**

Reversible shower seat with supporting leg

350×433×365 mm

205125035

323 €

**Atlenkiama dušo kėdutė**

Shower seat, transparent, polished

380×460×555 mm

326325056

138 €

**Atlenkiama dušo kėdutė su atrama**

Reversible shower seat with supporting leg

440×460×450 mm

301102181 blizgus/polished

301102182 matinis/brushed

225 €

237 €

**Nuimama rankena su tvirtinimo apdaila, nerūdijančio plieno**

Removable grab bar with cover, stainless steel, polished

450×100×70 mm

301507862

217 €

**Nuimama rankena su tvirtinimo apdaila, nerūdijančio plieno**

Removable grab bar with cover, stainless steel, polished

600×100×70 mm

301507852

226 €

**Atlošas su rankena, nuimamas nerūdijančio plieno, poliruotas**

Backrest with handle, removable, stainless steel, polished

400×180×230 mm

301507882

327 €

**Vonios rankena, blizgi**

Grab bar, polished

340×60×80 mm

106107011

25 €

**Vonios rankena kampu, blizgus**

Grab bar angled, polished

390×230×80 mm

106107021

33 €

**Vonios rankena kampu su muiline, blizgus**

Grab bar angled with Soap dish, polished

455×250×120 mm

106107031

44 €



Vonios aksesuarų rinkinys, 5vnt, plastikinis/baltas
Set of bathroom accessories, 5 pcs, plastic/white
290000209

Vonios aksesuarų rinkinys, 5vnt, plastikinis/baltas
Set of bathroom accessories, 5 pcs, plastic/black
290000208

68 €

68 €



Ženklas "WC" - A

WC

75×75×2 mm

111054006 blizgus/polished



8 €



Ženklas "WC moterims" - A

Ladies toilet

75×75×2 mm

111054007 blizgus/polished



8 €



Ženklas "WC vyrams" - A

Gentlemen toilet

75×75×2 mm

111054002 blizgus/polished



8 €



Ženklas "WC moterims ir vyrams" - A

Vyras ir moteris

75×75×2 mm

111054072 blizgus/polished



8 €



Ženklas "WC neįgaliems" - A

Disabled

75×75×2 mm

111054001 blizgus/polished



Ženklas "dušas" - A

Shower

75×75×2 mm

111054004 blizgus/polished



8 €



Ženklas "valytojos patalpa" - A

Cleaning room

75×75×2 mm

111054005 blizgus/polished



8 €



Ženklas „kūdikiams“ - A

Baby nursery room

75×75×2 mm

111054003 blizgus/polished



8 €



Ženklas "rūkymo vieta" - A

Smoking

75×75×2 mm

111054021 blizgus/polished



8 €



Ženklas "draudžiama rūkyti" - A

No smoking

75×75×2 mm

111054022 blizgus/polished



8 €



Tvirtinimo elementas ženklui

Wall pad for icon

65×65×2 mm

111054999

3 €

Užbaigtos meniu piktogramos
Complete menu icons

A

B

C

D

A

B

C

D

	vardas/name	Prekės kodas ordering number крѣг, бляськ žiedas, blizgus	Prekės kodas ordering number крѣг, мат žiedas, matinis	Prekės kodas ordering number квадрат, бляськ kvadratas, blizgus	Prekės kodas ordering number квадрат, мат kvadratas, matinis
	neįgaliems/disabled	111054001	111055001	111056001	111057001
	vyrams/man	111054002	111055002	111056002	111057002
	moterims/woman	111054007	111055007	111056007	111057007
	moterų ir vyrų/ man and woman	111054072	111055072	111056072	111057072
	vaiko ir tėvų vieta/ baby nursery room	111054003	111055003	111056003	111057003
	dušas/shower	111054004	111055004	111056004	111057004
	valytojos patalpa/ cleaning room	111054005	111055005	111056005	111057005
	wc/wc	111054006	111055006	111056006	111057006
	plaukiojimo baseinas/ swimming pool	111054008	111055008	111056008	111057008
	vaikai/children	111054009	111055009	111056009	111057009
	vaikų kampelis/ children's corner	111054010	111055010	111056010	111057010
	vežimų parduotuvė/ carriage house	111054011	111055011	111056011	111057011
	dviraičių namelis/bike shed	111054012	111055012	111056012	111057012
	Šiukšliadėžė/basket	111054013	111055013	111056013	111057013
	koplyčia/chapel	111054014	111055014	111056014	111057014
	kasos aparatas/cash register	111054015	111055015	111056015	111057015
	fitnesas/fitness	111054016	111055016	111056016	111057016
	rūbinė/cloakroom	111054017	111055017	111056017	111057017
	sūkurinė vonia/whirlpool	111054018	111055018	111056018	111057018
	sveikatingumo/wellness	111054019	111055019	111056019	111057019
	wi-fi/wi-fi	111054020	111055020	111056020	111057020
	leidžiama rūkyti/smoking	111054021	111055021	111056021	111057021
	nerūkyti/no smoking	111054022	111055022	111056022	111057022
	fotografuoti neleidžiama/ No photography allowed	111054023	111055023	111056023	111057023
	maistas draudžiamas/ food prohibited	111054024	111055024	111056024	111057024
	draudimas 1/ban 1	111054025	111055025	111056025	111057025
	draudimas 2/ban 2	111054026	111055026	111056026	111057026
	gyvūnai su pavadėliu/ animals on a leash	111054027	111055027	111056027	111057027
	augintiniai draudžiami/ pets prohibited	111054028	111055028	111056028	111057028
	skaičius/numeral	111054029	111055029	111056029	111057029
	eskalatorius/escalator	111054030	111055030	111056030	111057030
	eskalatorius žemyn/ escalator down	111054031	111055031	111056031	111057031
	eskalatorius aukštyn/ escalator up	111054032	111055032	111056032	111057032
	grindų/floor	111054033	111055033	111056033	111057033
	informacija/information	111054034	111055034	111056034	111057034
	virš pirmo aukšto/ above ground floor	111054035	111055035	111056035	111057035
	automobilių stovėjimo aikštelė/parking	111054036	111055036	111056036	111057036

	vardas/name	Prekės kodas ordering number крѣг, бляськ žiedas, blizgus	Prekės kodas ordering number крѣг, мат žiedas, matinis	Prekės kodas ordering number квадрат, бляськ kvadratas, blizgus	Prekės kodas ordering number квадрат, мат kvadratas, matinis
	grindų/floor	111054037	111055037	111056037	111057037
	žemyn laiptais/ down the stairs	111054038	111055038	111056038	111057038
	viršuje/upstairs	111054039	111055039	111056039	111057039
	požeminis aukštas/ underground floor	111054040	111055040	111056040	111057040
	kambarys/room	111054041	111055041	111056041	111057041
	brūkšny "aukštyn"/ dash "up"	111054042	111055042	111056042	111057042
	pull/pull	111054043	111055043	111056043	111057043
	pull-sem/pull-sem	111054044	111055044	111056044	111057044
	sem/sem	111054048	111055048	111056048	111057048
	sem-pull/sem-pull	111054049	111055049	111056049	111057049
	push/push	111054045	111055045	111056045	111057045
	push-tam/push-tam	111054046	111055046	111056046	111057046
	tam/tam	111054054	111055054	111056054	111057054
	tam/push	111054055	111055055	111056055	111057055
	priėmimas/reception	111054047	111055047	111056047	111057047
	rodyklė/arrow	111054050	111055050	111056050	111057050
	dvikryptė rodyklė/ bidirectional arrow	111054051	111055051	111056051	111057051
	įstrižainė rodyklė į kairę/ diagonal left arrow	111054052	111055052	111056052	111057052
	įstrižainė rodyklė dešinėn/ diagonal right arrow	111054053	111055053	111056053	111057053
	avarinis išėjimas/ emergency exit	111054056	111055056	111056056	111057056
	įėjimas/entrance	111054057	111055057	111056057	111057057
	išeiti/exit	111054058	111055058	111056058	111057058
	pakelti/lift	111054059	111055059	111056059	111057059
	baras/bar	111054060	111055060	111056060	111057060
	kavinė/cafe	111054061	111055061	111056061	111057061
	virtuvė/kitchen	111054062	111055062	111056062	111057062
	restoranas/restaurant	111054063	111055063	111056063	111057063
	saugos kamera/ safety camera	111054064	111055064	111056064	111057064
	dezinfekcija/disinfection	111054065	111055065	111056065	111057065
	gesintuvas/ fire extinguisher	111054066	111055066	111056066	111057066
	pirmosios pagalbos rinkinys/ first aid kit	111054067	111055067	111056067	111057067
	priešgaisrinė žarnos/ fire hose	111054068	111055068	111056068	111057068
	tarpai/spacing	111054069	111055069	111056069	111057069
	dengianti burną/ covering mouth	111054070	111055070	111056070	111057070
	sanitaras/paramedic	111054071	111055071	111056071	111057071



Ženklas "WC vyrams"

Gentlemen's toilet
120×130×2 mm
111022032 blizgus/polished
111022035 matinis/matt **22 €**

Ženklas "WC moterims"

Ladies' toilets
120×130×2 mm
111022042 blizgus/polished
111022045 matinis/matt **22 €**

Ženklas "WC neįgaliems"

Disabled toilets
120×130×2 mm
111022022 blizgus/polished
111022025 matinis/matt **22 €**

Ženklas "WC"

WC
120×120×2 mm
111022082 blizgus/polished
111022085 matinis/matt **22 €**



Ženklas "dušas"

Showers
120×120×2 mm
111022072 blizgus/polished
111022075 matinis/matt **26 €**

Ženklas "valytojos patalpa"

Cleaning room
120×120×2 mm
111022092 blizgus/polished
111022095 matinis/matt **19 €**

Ženklas "rūkymo vieta"

Smoking
120×140×2 mm
111022012 blizgus/polished
111022015 matinis/matt **23 €**

Ženklas "draudžiama rūkyti"

No smoking
120×140×2 mm
111022052 blizgus/polished
111022055 matinis/matt **23 €**



Ženklas „kūdikiams“

Baby nursery room
120×120×2 mm
111022062 blizgus/polished
111022065 matinis/matt **19 €**

Ženklas "WC"

WC
80×35×2 mm
108022072 blizgus/polished
108022075 matinis/matt **10 €**

Ženklas "WC moterims"

Ladies toilet
40×85×2 mm
108022062 blizgus/polished
108022065 matinis/matt **10 €**

Ženklas "WC vyrams"

Gentlemen toilet
40×85×2 mm
108022052 blizgus/polished
108022055 matinis/matt **10 €**



Kūdikų vystymo stalas, plastikas

Wall mounted baby changing station, horizontal, plastic
855×585×107 mm
138235016

346 €

Kūdikų vystymo stalas, plastikas - matinis nerūdijantis plienas

Wall mounted baby changing station, SS-plastic, brushed
900×510×105 mm
138235035

1220 €



Kūdikų vystymo stalas, plastikas

Babychanging station, plastic
550×900×140 mm
138235026

449 €

Veidrodis, nerūdijančio plieno

Mirror - stainless supermirror
600×800 mm
101301652

173 €

Veidrodis su LED apšvietimu

Mirror with LED illuminated frame
1200×600×35 mm, 8 W
127201719

357 €

VONIOS KAMBARIO PRIEDAI

SHOWER PROGRAMM



Dušo latakas PLUS, nerūdijantis plienas

Shower channel PLUS, stainless steel

d×67×120 mm

254653011 d = 550
254653021 d = 650
254653031 d = 750



Dušo latakas, nerūdijantis plienas

Shower channel, stainless steel

d×71×110 mm

91 € 254653111 d = 540
98 € 254653121 d = 640
105 € 254653131 d = 740

62 €
68 €
73 €



INOKS



KARE



LINE



INOKS



KARE



LINE



INOKS



KARE



LINE

Grotelės dušo latakas

254653011, 254653311

Grate for shower channel 254653011, 254653111

d = 500 mm

254657815 INOKS
254657015 KARE
254657415 LINE

28 €
28 €
28 €

Grotelės dušo latakas

254653121, 254653021

Grate for shower channel 254653021, 254653121

d = 600 mm

254657825 INOKS
254657025 KARE
254657425 LINE

29 €
29 €
29 €

Grotelės dušo latakas

254653131, 254653031

Grate for shower channel 254653031, 254653131

d = 700 mm

254657835 INOKS
254657035 KARE
254657435 LINE

31 €
31 €
31 €



203125074

203025074



Atlenkiama dušo kėdutė

Shower seat

350×70×340 mm

203125064

99 €

Atlenkiama dušo kėdutė

Shower seat

350×70×340 mm

203125074

203025074

149 €

149 €

Atlenkiama dušo kėdutė su atrama

Folding shower seat with supporting leg

350×433×365 mm

205125035

323 €



Dušo stovas, žalvaris chromuotas

Shower rail with holder, chromed brass

90×650×70 mm

104114112

85 €



Dušo stovas, žalvaris chromuotas

Shower rail with holder, chromed brass

90×600×70 mm

122614262

14 €

! Išpardavimas, prekių kiekis ribotas.
• Till sold out.



Metaliniai dušo užuolaidų kabliukai, 12 vnt

Stainless steel hooks for shower curtains, 12 pc.

42×73×8 mm

153653502

10 €

Dušo užuolaidos, baltos, PEVA plastikas

Shower curtain, white, PEVA plastic

153653016 180 × 180 cm

180 cm × 180 cm, dušo strypui/for shower curtain: 101120071, 101114361

153653026 200 × 180 cm

200 cm × 180 cm, dušo strypui/for shower curtain: 101120081, 101120012

153653036 240 × 180 cm

240 cm × 180 cm, dušo strypui/for shower curtain: 101120091, 101120022, 101120111, 101120042

153653046 300 × 180 cm

300 cm × 180 cm, dušo strypui/for shower curtain: 101120101, 101120032

153653066 360 × 180 cm

360 cm × 180 cm, dušo strypui/for shower curtain: 101120121, 101120052

12 €

13 €

17 €

22 €

27 €



Plastikiniai dušo užuolaidų kabliukai, 12 vnt

Plastic hooks for shower curtains, 12 pc.

54×80×10 mm

153653506

3 €



Dušo užuolaidos laikiklis tiesus, nerūdijančio plieno*

Shower curtain holder, foldable, stainless steel, polished*

101120071 ø 25 mm, 900 × 60 × 60 mm

101120081 ø 25 mm, 1 000 × 60 × 60 mm

101120091 ø 25 mm, 1 500 × 60 × 60 mm

101120101 ø 25 mm, 2 000 × 60 × 60 mm

52 €

58 €

69 €

81 €

Dušo užuolaidos laikiklis tiesus, nerūdijančio plieno*

Shower curtain holder, stainless steel, polished*

101114361 ø 25 mm, 900 × 55 × 55 mm

101120012 ø 25 mm, 1 000 × 55 × 55 mm

101120022 ø 25 mm, 1 500 × 55 × 55 mm

101120032 ø 25 mm, 2 000 × 55 × 55 mm

61 €

64 €

76 €

89 €



Dušo užuolaidos laikiklis kampinis, sulankstomas, juodas*

Shower curtain holder, corner model, stainless steel, čėrná*

101120110

115 €



Dušo užuolaidos laikiklis kampinis, sulankstomas, nerūdijančio plieno*

Shower curtain holder, corner model, foldable, stainless steel, polished*

101120111 ø 25 mm, 900 × 500 × 900 mm

101120231 ø 25 mm, 1 300 × 500 × 1 300 mm

101120121 ø 25 mm, 1 400 × 500 × 1 400 mm

115 €

146 €

152 €

Dušo užuolaidos laikiklis kampinis, nerūdijančio plieno*

Shower curtain holder, corner model, stainless steel, polished*

101120042 ø 25 mm, 900 × 500 × 900 mm

101120052 ø 25 mm, 1 400 × 500 × 1 400 mm

127 €

151 €

* Prekė tiekiamą be dušo užuolaidos.
The rods are supplied without a shower curtain.

Dušo užuolaidų laikiklis pagal individualų užsakymą

Assemble your custom shower curtain holder from our components

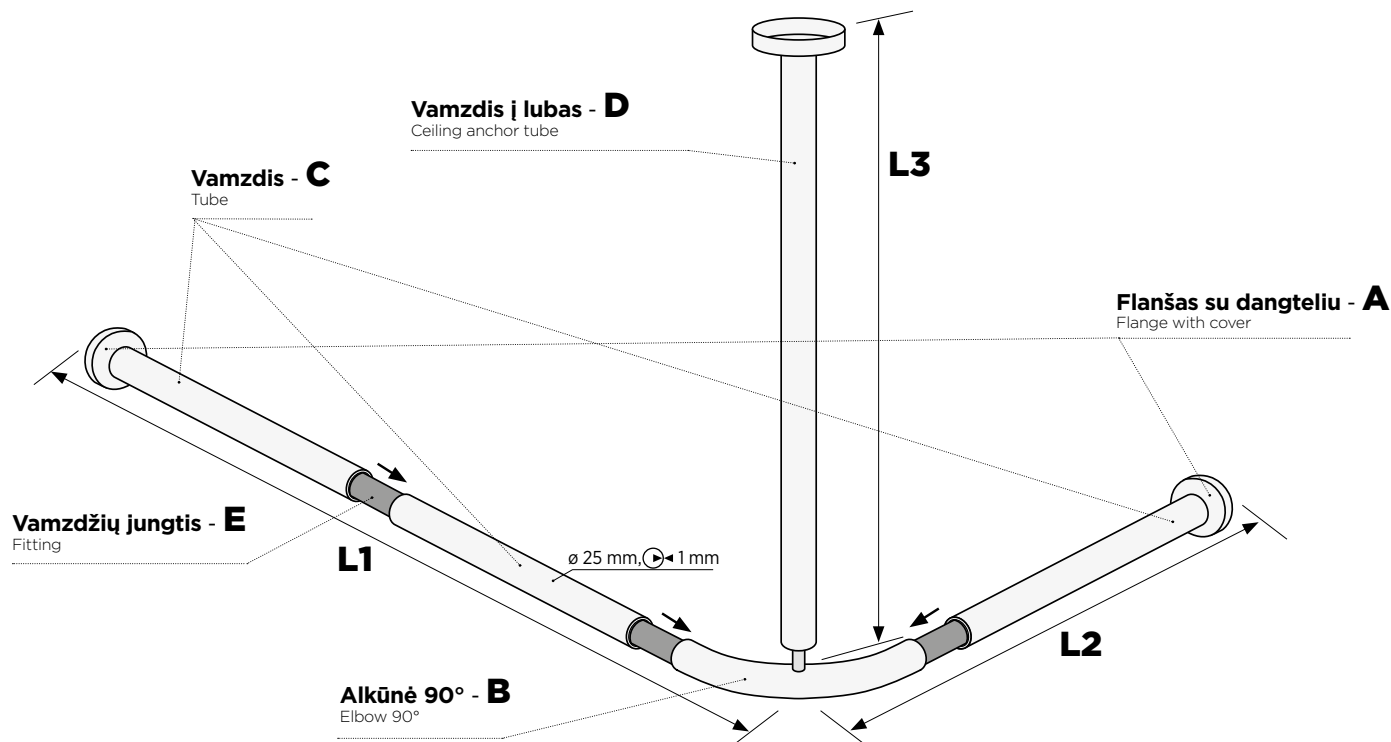

Individualaus ilgio matavimo procedūra dušo užuolaidų strypai:
 Procedure for measuring individual lengths of shower curtain rods:

L1:	$A + B$	$+ C + C$
	$= 100 \text{ mm}$	
L2:	$A + B$	$+ C$
	$= 100 \text{ mm}$	
L3:	D	



Flanšas su dangteliu - A

Flange with cover, including assembly package

101120132

18 €

Vamzdžių jungtis - E

Fitting

101120152

Alkūnė 90° + 2 jungtys - B

Elbow 90° + 2x fitting

101120222

8 €

23 €



Vamzdis - C Tube		
600 mm	101120162	10 €
700 mm	101120172	11 €
800 mm	101120182	12 €
900 mm	101120192	13 €
1000 mm	101120202	14 €
1170 mm	101120271	18 €



Vamzdis į lubas - D Ceiling anchor tube		
300 mm	101120241	53 €
500 mm	101120142	56 €
800 mm	101120251	60 €
1200 mm	101120261	67 €

NERŪDIJANTIS PLIENAS

STAINLESS STEEL PRODUCT RANGE

Medžiaga
Material

nerūdijantis plienas
stainless steel

plastmasinis
plastic

veidrodinis
mirror

Paviršiaus apdaila
Surface finish

Šukuotas
Brushed



Popierinių nosinių laikiklis

Paper tissue dispensers

273×123 ×78 mm

101003025

85 €

Vienkartinių pirštinių dozatorius

Disposable gloves dispenser

252×138×88 mm

101003215

44 €

Popierinių rankšluosčių dozatorius

Paper towel dispenser

265×192×120 mm

101003045

117 €

Popierinių rankšluosčių dozatorius su muilo dozatoriumi

Paper towel dispenser with soap dispenser

384×336×115 mm, 1 100 ml

101003205

256 €



Popierinių rankšluosčių dozatorius, atviras

Paper towel dispenser open

265×192×120 mm

101003235

77 €

265×375×120 mm

101003275

99 €

Popierinių rankšluosčių dozatorius

Paper towel dispenser

298×448×124 mm

101003245

176 €

Popierinių rankšluosčių dozatorius, atviras

Paper towel dispenser

298×448×124 mm

101003255

247 €

Veidrodinė spintelė su popierinių rankšluosčių ir skysto muilo dozatoriumi

A mirror cabinet with a dispenser for paper towels and liquid soap

400×455×140 mm

101003265

382 €



Drėgno wc popieriaus dozatorius

Dispenser for wet toilet paper

173×78×145 mm

101003225

75 €

WC popieriaus laikiklis (7 vnt)

Toilet paper dispenser (7 pcs)

130×679×120 mm

101003165

75 €

Wc popieriaus laikiklis su spintele

Toilet paper holder with cabinet

205×135×147 mm

101012175

116 €

Dvigubas WC popieriaus laikiklis

Double toilet paper holder

254×53×67 mm

101012045

55 €



WC popieriaus laikiklis

Toilet paper holder

143×111×90 mm

101012015

44 €

Dvigubas WC popieriaus laikiklis su dangteliu

Double toilet paper holder

243×111×90 mm

101012185

55 €

WC šepėčių dėžutė

Toilet brush box

148×448×129 mm

101013175

217 €

WC šepėčio laikiklis, pakabinamas

Wall mounted toilet brush holder

110×400×115 mm

101113335

33 €



Muilo dozatorius (1 100 ml)
Soap dispenser (1 100 ml)

123×336×115 mm
101009415



**Ant stalviršio montuojama anga
šiukšliadėžei**

Countertop-mounted circular waste chute
170×42×170 mm, ø 135 mm

175 € 101015315



**Ant stalviršio montuojamas
šiukšliadėžės dangtelis**

Countertop-mounted lid trash bin cover
300×105×30 mm

55 € 101015335 98 €



Šiukšliadėžė be dangčio

Waste bin
298×448×170 mm, 21 l
101015305

105 €



**Šiukšliadėžė su higieninių maišelių
dozatoriumi ir plastikiniu konteineriu**

A waste bin with a dispenser for sanitary bags
and a plastic container
298×448×170 mm, 6,5 l

101015295



**Šiukšliadėžė su higieninių maišelių
dozatoriumi**

Waste bin with dispenser for sanitary bags
300×450×130 mm, 4 l

100 € 101015325 322 €



**Įleidžiama šiukšliadėžė
su higieninių maišelių
dozatoriumi**

Recessed waste bin with dispenser for
sanitary bags

226×570×130 mm, 4 l
101015345

178 €



Šiukšliadėžė su įdėklų

Wired waste bin in receptacle
300×560×330 mm, 45 l

101015355

466 €

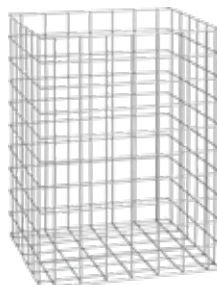

Šiukšliadėžė

Wired waste bin
353×503×305 mm, 52 l

101015065

140 €

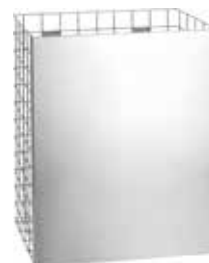

Šiukšliadėžė pakabinama

Hanging wired waste bin with fixed front
455×603×255 mm, 67 l

101015365

210 €

101042065

101042075

Pisuart pertvara

Urinal partition
60×860×400 mm

101042065

149 €

30×800×390 mm

101042075

159 €

**Apsauga rankų džiovintuvui
nuo vandens lašų**

Splash guard for hand dryer
30×800×390 mm

101044050 juoda/black

91 €

101044055 blizgus/polished

80 €

101043065 matinis/matt

80 €

**Apsauga rankų džiovintuvui
nuo vandens lašų, klijuojama**

Splash guard for hand dryer for sticking
30×800×390 mm

101043050 juoda/black

91 €

101043055 blizgus/polished



























80 €



























101043065 matinis/matt

























80 €

























ATSARGINĖS DALYS

















SPARE PARTS

























Prekė Product	Atsarginė dalis Spare part	Kaina Price	Prekės kodas Ordering number
OBLA			
165113012	 WC šepetys su kotu Spare WC brushed with handle	9 €	131567113
165113012	 WC šepėčio galva Spare WC brushed without handle	7 €	131567008
165113012	 Atsarginė rankena Spare handle	7 €	131567013
165113012	 WC šepėčio indas atsarginis Glass dish for WC brushed, frosted	9 €	131567003
165108042	 Muilinė atsarginė matinė Soap dish, frosted	10 €	131567716
165110012	 Stiklinė atsarginė matinė Glass cup, frosted	10 €	131567717
65109017	 Dozatorius muilo atsarginis, matinis Glass for soap dispenser, frosted	10 €	131567724
165109017	 Pompa muilo dozatoriui Spare pump complete	29 €	131567765
STELLA			
166113012	 WC šepetys su kotu Spare WC brushed with handle	13 €	131567009
166113012	 WC šepėčio galva Spare WC brushed without handle	7 €	131567008
166113012	 Atsarginė rankena Spare handle	7 €	131567013
166110012	 WC šepėčio indas atsarginis Glass dish for WC brushed, frosted	9 €	131567003
166108042	 Muilinė atsarginė matinė Soap dish, frosted	10 €	131567716
166110012	 Stiklinė atsarginė matinė Glass cup, frosted	10 €	131567717
166109017	 Dozatorius muilo atsarginis, matinis Glass for soap dispenser, frosted	10 €	131567724
165109017	 Pompa muilo dozatoriui Spare pump complete	29 €	131567765
CIRCUM			
168113012	 WC šepetys su kotu Spare WC brushed with handle	6 €	131567764
168113012	 WC šepėčio galva Spare WC brushed without handle	2 €	131567767
168113012	 Atsarginė rankena Spare handle	4 €	131567766
168113012	 WC šepėčio indas atsarginis Glass dish for WC brushed, frosted	5 €	131567736
168108042	 Muilinė atsarginė matinė Soap dish, frosted	3 €	131567742
168110012	 Stiklinė atsarginė matinė Glass cup, frosted	3 €	131567743
168109017	 Dozatorius muilo atsarginis, matinis Glass for soap dispenser, frosted	4 €	131567739
168109017	 Pompa muilo dozatoriui Spare pump complete	9 €	131567763
QUADRA			
169113012	 WC šepetys su kotu Spare WC brushed with handle	6 €	131567764
169113012	 WC šepėčio galva Spare WC brushed without handle	2 €	131567767

























Prekė Product	Atsarginė dalis Spare part	Kaina Price	Prekės kodas Ordering number
169113012	 Atsarginė rankena Spare handle	4 €	131567766
169113012	 WC šepėčio indas atsarginis Glass dish for WC brushed, frosted	5 €	131567736
169108042	 Muilinė atsarginė matinė Soap dish, frosted	3 €	131567742
169110012	 Stiklinė atsarginė matinė Glass cup, frosted	3 €	131567743
169109017	 Dozatorius muilo atsarginis, matinis Glass for soap dispenser, frosted	4 €	131567739
169109017	 Pompa muilo dozatoriui Spare pump complete	9 €	131567763
ORGANIC BLACK			
167113140	 WC šepetys su kotu Spare WC brushed with handle	14 €	131567754
167113140	 WC šepėčio galva Spare WC brushed without handle	5 €	131567755
167113140	 Atsarginė rankena Spare handle	9 €	131567756
167113060	 WC šepetys su kotu Spare WC brushed with handle	18 €	131567758
167113060	 WC šepėčio galva Spare WC brushed without handle	10 €	131567656
167113060	 Atsarginė rankena Spare handle	9 €	131567759
167113140	 WC šepėčio indas atsarginis Glass dish for WC brushed, frosted	17 €	131567653
167111010	 Stiklinė atsarginė matinė Glass cup, frosted	7 €	131567762
157132016	 Muilo dozatoriaus atidarytuvas Soap dispenser key	3 €	157132016
ORGANIC			
157113141	 WC šepetys su kotu Spare WC brushed with handle	21 €	131567650
157113061	 WC šepetys su kotu ir dangteliu silikoninė Spare WC silicone brushed incl. handle with vessel cover	29 €	131567655
157113141	 WC šepėčio galva Spare WC brushed without handle	9 €	131567651
157113061	 WC šepėčio galva silikoninė Spare WC silicone brushed without handle	10 €	131567656
157113141	 WC šepėčio indas atsarginis Glass dish for WC brushed, frosted	17 €	131567653
157132016	 Muilo dozatoriaus atidarytuvas Soap dispenser key	3 €	157132016
GALLA			
108113010	 WC šepetys su kotu Spare WC brushed with handle	17 €	131567446
108113010	 WC šepėčio galva Spare WC brushed without handle	7 €	131567008c
108108020	 Muilinė atsarginė, polyresin Glass soap dish, polyresin	15 €	131567470
108110010	 Stiklinė atsarginė, polyresin Glass cup, polyresin	15 €	131567465
108109010	 Pompa muilo dozatoriui su dangteliu Spare pump complete, with cover	32 €	131567466





























Prekē Product	Atsarginē dalis Spare part	Kaina Price	Prekēs kods Ordering number
GAMMA			
145713314 145513092 145413092 145613310	 WC šepetys su kotu Spare WC brushed with handle	30 €	131567458
145713324	 Atsarginis tualeta šepetys su kotu su indo dangteliu Spare WC brush incl. handle with vessel cover	14 €	131567459
145613320	 Atsarginis tualeta šepetys su kotu su indo dangteliu Spare WC brush incl. handle with vessel cover	14 €	131567474
145413092 145613310 145513092 145713314	 WC šepečio galva Spare WC brushed without handle	7 €	131567008
145413092 145613310 145513092 145713314	 WC šepečio galva Spare WC brushed without handle	7 €	131567008c
145609320 145709324	 Pompa muilo dozatoriui įskaitant muilo dozatorių talpyklos Spare pump complete incl. containers, chrome	295,-	131567457
145709324	 Pompa muilo dozatoriui Spare pump complete, chrome	30 €	131567456
BRILO			
161113017 161313060	 WC šepečio galva Spare WC brushed without handle	7 €	131567008c
161113017 161313060	 WC šepečio galva Spare WC brushed without handle	7 €	131567008
161113017	 WC šepečio indas atsarginis Glass dish for WC brushed, frosted	9 €	131567003
161108042	 Muilinė atsarginė matinė Soap dish, frosted	8 €	131567002m
161110012	 Stiklinė atsarginė matinė Glass cup, frosted	8 €	131567001m
161109102	 Dozatorius muilo atsarginis, matinis Glass for soap dispenser, frosted	16 €	131567111
161109102	 Pompa muilo dozatoriui Spare pump complete	34 €	131567584
SABLO			
160113017 160313060	 WC šepečio galva Spare WC brushed without handle	7 €	131567008c
160113017 160313060	 WC šepečio galva Spare WC brushed without handle	7 €	131567008
160113017	 WC šepečio indas atsarginis Glass dish for WC brushed, frosted	9 €	131567003
160108042	 Muilinė atsarginė matinė Soap dish, frosted	8 €	131567002m
160110012	 Stiklinė atsarginė matinė Glass cup, frosted	8 €	131567001m
160109102	 Dozatorius muilo atsarginis, matinis Glass for soap dispenser, frosted	16 €	131567111
160109102	 Pompa muilo dozatoriui Spare pump complete	34 €	131567583
CORAL			
158113017 158313067	 WC šepečio galva Spare WC brushed without handle	7 €	131567008
158113017 158313067	 WC šepečio galva Spare WC brushed without handle	7 €	131567008c
158113017	 WC šepečio indas atsarginis Glass dish for WC brushed, frosted	9 €	131567003
158108042	 Muilinė atsarginė matinė Soap dish, frosted	8 €	131567002m

Prekē Product	Atsarginē dalis Spare part	Kaina Price	Prekēs kods Ordering number
158110012	 Stiklinė atsarginė matinė Glass cup, frosted	8 €	131567001m
158109102	 Dozatorius muilo atsarginis, matinis Glass for soap dispenser, frosted	16 €	131567111
158109102	 Pompa muilo dozatoriui Spare pump complete	37 €	131567550
AMBER			
155113017 155313067	 WC šepečio galva Spare WC brushed without handle	7 €	131567008
155113017 155313067	 WC šepečio galva Spare WC brushed without handle	7 €	131567008c
155113017	 WC šepečio indas atsarginis Glass dish for WC brushed, frosted	9 €	131567003
155108042	 Muilinė atsarginė matinė Soap dish, frosted	8 €	131567002m
155110012	 Stiklinė atsarginė matinė Glass cup, frosted	8 €	131567001m
155109102	 Dozatorius muilo atsarginis, matinis Glass for soap dispenser, frosted	16 €	131567111
155109102	 Pompa muilo dozatoriui Spare pump complete	37 €	131567552
HEMATIT			
159113017 159313067	 WC šepečio galva Spare WC brushed without handle	7 €	131567008
159113017 159313067	 WC šepečio galva Spare WC brushed without handle	7 €	131567008c
159113017	 WC šepečio indas atsarginis Glass dish for WC brushed, frosted	9 €	131567003
159108042	 Muilinė atsarginė matinė Soap dish, frosted	8 €	131567002m
159110012	 Stiklinė atsarginė matinė Glass cup, frosted	8 €	131567001m
159109102	 Dozatorius muilo atsarginis, matinis Glass for soap dispenser, frosted	16 €	131567111
159109102	 Pompa muilo dozatoriui Spare pump complete	37 €	131567549
GRAPHIT			
156113017 156313067	 WC šepečio galva Spare WC brushed without handle	7 €	131567008
156113017 156313067	 WC šepečio galva Spare WC brushed without handle	7 €	131567008c
156113017	 WC šepečio indas atsarginis Glass dish for WC brushed, frosted	9 €	131567003
156108042	 Muilinė atsarginė matinė Soap dish, frosted	8 €	131567002m
156110012	 Stiklinė atsarginė matinė Glass cup, frosted	8 €	131567001m
156109102	 Dozatorius muilo atsarginis, matinis Glass for soap dispenser, frosted	16 €	131567111
156109102	 Pompa muilo dozatoriui Spare pump complete	37 €	131567551
OMEGA			
104113012 104113102 104836012 104913092 104913112 104913122 104913152	 WC šepetys su kotu Spare WC brushed with handle	13 €	131567009





























Prekė Product	Atsarginė dalis Spare part	Kaina Price	Prekės kodas Ordering number
104113107 104113017 104836012 104913092 104913117 104913122 104913152	 WC šepetys su kotu Spare WC brushed with handle	13 €	131567009c
102313066	 WC šepetys su kotu ir dangteliu Spare WC brushed incl. handle with vessel cover	27 €	131567054b
102313067	 WC šepetys su kotu ir dangteliu Spare WC brushed incl. handle with vessel cover	27 €	131567054
102313057 102313066 104113012 104113107 104836012 104913090 104913092 104913112 104913117 104913122 104913152	 WC šepėčio galva Spare WC brushed without handle	7 €	131567008
102313066 102313057 104113012 104113107 104836012 104913090 104913092 104913112 104913117 104913122 104913152	 WC šepėčio galva Spare WC brushed without handle	7 €	131567008c
104113102 104113107 104113012 104113017	 WC šepėčio indas atsarginis Glass dish for WC brushed, frosted	9 €	131567003
104108042 138108191	 Muilinė atsarginė matinė Soap dish, frosted	8 €	131567002m
104110012 104110022 104110042 138110061	 Stiklinė atsarginė matinė Glass cup, frosted	8 €	131567001m
104109017 104019012	 Dozatorius muilo atsarginis matinis Glass for soap dispenser, frosted	35 €	131567243
104109102 104109182	 Dozatorius muilo atsarginis, matinis Glass for soap dispenser, frosted	16 €	131567111
138709041 138109161	 Dozatorius muilo atsarginis su pompa Glass for soap dispenser with pump	10 €	131567147
104019012 104109012 104109017 104109102 104109182	 Pompa muilo dozatoriui Spare pump complete, chrome	22 €	131567204
104609172 138109161 138709041	 Pompa muilo dozatoriui Spare pump	9 €	131567007
104109032	 Pompa muilo dozatoriui mýdla Spare pump complete, chrome	22 €	131567157
104122042	 Stiklas lentynėlei atsarginis, matinis Glass for shelf, frosted	10 €	131567117
104102042	 Stiklas lentynėlei atsarginis, matinis Glass for shelf, frosted	12 €	131567011
104102012	 Stiklas lentynėlei atsarginis, matinis Glass for shelf, frosted	11 €	131567047



























Prekė Product	Atsarginė dalis Spare part	Kaina Price	Prekės kodas Ordering number
WHITE			
104913094 104113014	 WC šepetys su kotu Spare WC brushed with handle	15 €	131567162
104913094 102313064 104113014	 WC šepėčio galva Spare WC brushed without handle	7 €	131567008
104913094 102313064 104113014	 WC šepėčio galva Spare WC brushed without handle	7 €	131567008c
102913094	 WC šepėčio galva Spare WC brushed without handle	5 €	131567384c
104113014	 WC šepėčio indas atsarginis Glass dish for WC brushed, frosted	9 €	131567003
104108044	 Muilinė atsarginė matinė Soap dish, frosted	8 €	131567002m
104110014	 Stiklinė atsarginė matinė Glass cup, frosted	8 €	131567001m
104109014	 Dozatorius muilo atsarginis matinis Glass for soap dispenser, frosted	35 €	131567243
104109104	 Dozatorius muilo atsarginis, matinis Glass for soap dispenser, frosted	16 €	131567111
104109014 104109104	 Pompa muilo dozatoriui Spare pump complete, white	22 €	131567409
104102044	 Stiklas lentynėlei atsarginis, matinis Glass for shelf, frosted	17 €	131567429
DARK			
104113010 104913090	 WC šepetys su kotu Spare WC brushed with handle	15 €	131567404
102313060 104113010 104913090	 WC šepėčio galva Spare WC brushed without handle	7 €	131567008c
104113010	 WC šepėčio indas atsarginis Glass dish for WC brushed, frosted	9 €	131567003
104108040	 Muilinė atsarginė matinė Soap dish, frosted	8 €	131567002m
104110010	 Stiklinė atsarginė matinė Glass cup, frosted	8 €	131567001m
104109010	 Dozatorius muilo atsarginis matinis Glass for soap dispenser, frosted	35 €	131567243
104109100	 Dozatorius muilo atsarginis, matinis Glass for soap dispenser, frosted	16 €	131567111
104109010 104109100	 Pompa muilo dozatoriui Spare pump complete, chrome	22 €	131567239
104102040	 Stiklas lentynėlei atsarginis, matinis Glass for shelf, frosted	12 €	131567011
NEO			
102313065	 WC šepetys su kotu ir dangteliu Spare WC brushed incl. handle with vessel cover	29 €	131567120
102313069	 WC šepetys su kotu ir dangteliu Spare WC brushed incl. handle with vessel cover	29 €	131567120
102313075 104113015 104113105	 WC šepetys su kotu Spare WC brushed with handle	14 €	131567031a
102313079 104113019 104113109	 WC šepetys su kotu Spare WC brushed with handle	14 €	131567031c
102313055 102313065 102313075 104113015 104113105	 WC šepėčio galva Spare WC brushed without handle	7 €	131567008

























Prekē Product	Atsarginē dalis Spare part	Kaina Price	Prekēs kods Ordering number
102313059 102313069 102313079 104113019 104113109	 WC šepetis galva Spare WC brushed without handle	7 €	131567008c
104113015 104113019 104113105 104113109	 WC šepetis indas atsarginis Glass dish for WC brushed, frosted	9 €	131567003
104108045	 Muilinē atsarginē matinē Soap dish, frosted	8 €	131567002m
104110015 104210025	 Stiklinē atsarginē matinē Glass cup, frosted	8 €	131567001m
104109016	 Dozatorius muilo atsarginis matinis Glass for soap dispenser, frosted	35 €	131567243
104109115	 Dozatorius muilo atsarginis, matinis Glass for soap dispenser, frosted	16 €	131567111
104109035	 Pompa muilo dozatoriui Spare pump complete, chrome	22 €	131567156
104109015 104109016 104109115	 Pompa muilo dozatoriui Spare pump complete, chrome	23 €	131567205
104102045	 Stiklas lentynēlei atsarginis, matinis Glass for shelf, frosted	12 €	131567011
104102015	 Stiklas lentynēlei atsarginis, matinis Glass for corner shelf, frosted	11 €	131567047
BETA			
132113012	 WC šepetys su kotu Spare WC brushed with handle	13 €	131567009
132113017	 WC šepetys su kotu Spare WC brushed with handle	13 €	131567009c
132113012	 WC šepetis galva Spare WC brushed without handle	7 €	131567008
132113017	 WC šepetis galva Spare WC brushed without handle	7 €	131567008c
132108042	 Muilinē atsarginē matinē Soap dish, frosted	8 €	131567002m
132110012 132110022 132110042	 Stiklinē atsarginē matinē Glass cup, frosted	8 €	131567001m
132109017	 Dozatorius muilo atsarginis matinis Glass for soap dispenser, frosted	35 €	131567243
132109102 132109182	 Dozatorius muilo atsarginis, matinis Glass for soap dispenser, frosted	16 €	131567111
132122042	 Stiklas lentynēlei atsarginis, matinis Glass for shelf, frosted	10 €	131567117
132102042	 Stiklas lentynēlei atsarginis, matinis Glass for shelf, frosted	12 €	131567011
132102012	 Stiklas lentynēlei atsarginis, matinis Glass for corner shelf, frosted	11 €	131567047
132109017 132109102 132109182	 Pompa muilo dozatoriui Spare pump complete, chrome	22 €	131567204
EASY/EASY01			
163113065 164113065	 WC šepetys su kotu Spare WC brushed with handle	20 €	131567772
163113061 164113061	 WC šepetys su kotu Spare WC brushed with handle	22 €	131567773
163113060 164113060	 WC šepetys su kotu Spare WC brushed with handle	24 €	131567774









Prekē Product	Atsarginē dalis Spare part	Kaina Price	Prekēs kods Ordering number
VIA			
118113092	 WC šepetys su kotu ir dangteliu Spare WC brushed incl. handle with vessel cover	44 €	131567142
135013012	 WC šepetys su kotu ir dangteliu Spare WC brushed incl. handle with vessel cover	13 €	131567386
118113092	 WC šepetis galva Spare WC brushed without handle	7 €	131567158
118213092	 WC šepetis galva Spare WC brushed without handle	7 €	131567282
135913091	 WC šepetis galva Spare WC brushed without handle	5 €	131567384c
118213092	 WC šepetis galva Spare WC brushed without handle	5 €	131567012c
135013012	 WC šepetis indas atsarginis Glass dish for WC brushed, frosted	14 €	131567253
135008022	 Muilinē atsarginē matinē Soap dish, frosted	9 €	131567250
135011012	 Stiklinē atsarginē matinē Glass cup, frosted	9 €	131567249
135009042	 Dozatorius muilo atsarginis matinis Glass for soap dispenser, frosted	13 €	131567251
135009042	 Pompa muilo dozatoriui Spare pump complete, chrome	22 €	131567204
135002242	 Stiklas lentynēlei atsarginis, matinis Glass for shelf, frosted	23 €	131567254
NERO			
135013010	 WC šepetys su kotu Spare WC brushed with handle	17 €	131567365
135913090 135013010	 WC šepetis galva Spare WC brushed without handle	5 €	131567384c
135913160	 WC šepetis galva Spare WC brushed without handle	10 €	131567282
135013010	 WC šepetis indas atsarginis Glass dish for WC brushed, frosted	14 €	131567253
135008020	 Muilinē atsarginē matinē Soap dish, frosted	9 €	131567250
135011010	 Stiklinē atsarginē matinē Glass cup, frosted	9 €	131567249
135009040	 Dozatorius muilo atsarginis matinis Glass for soap dispenser, frosted	13 €	131567251
135009040	 Pompa muilo dozatoriui Spare pump complete, chrome	22 €	131567239
135002240	 Stiklas lentynēlei atsarginis, matinis Glass for shelf, frosted	23 €	131567254
SOLO			
139113142	 WC šepetys su kotu Spare WC brushed with handle	11 €	131567417
139113142	 WC šepetis galva Spare WC brushed without handle	7 €	131567049
135913162	 WC šepetis galva Spare WC brushed without handle	7 €	131567282
139113142	 WC šepetis indas atsarginis Glass dish for WC brushed, frosted	17 €	131567123
139108032	 Muilinē atsarginē matinē Soap dish, frosted	9 €	131567250
139110012	 Stiklinē atsarginē matinē Glass cup, frosted	9 €	131567249
139109042	 Dozatorius muilo atsarginis, matinis Glass for soap dispenser, frosted	13 €	131567251

■B ATSARGINĖS DALYS/SPARE PARTS

Prekė Product	Atsarginė dalis Spare part	Kaina Price	Prekės kodas Ordering number
139109042	 Pompa muilo dozatoriui Spare pump complete, chrome	22 €	131567063
139102312	 Stiklas lentynėlei atsarginis, matinis Glass for shelf, frosted	10 €	131567104
ALFA			
102413012	 WC šepetys su kotu Spare WC brushed with handle	13 €	131567018
102413012	 WC šepetys su kotu Spare WC brushed with handle	13 €	131567018c
102413012	 WC šepėčio galva Spare WC brushed without handle	5 €	131567012
102413012	 WC šepėčio galva Spare WC brushed without handle	5 €	131567012c
102413012	 WC šepėčio indas atsarginis Glass dish for WC brushed, frosted	9 €	131567113
102408023	 Muilinė atsarginė matinė Soap dish, frosted	8 €	131567002m
102410012	 Stiklinė atsarginė matinė Glass cup, frosted	5 €	131567378
102408022	 Dozatorius muilo atsarginis matinis Glass for soap dispenser, frosted	10 €	131567380
102408022	 Pompa muilo dozatoriui Spare pump complete, chrome	10 €	131567382
102402242	 Stiklas lentynėlei atsarginis, matinis Glass for shelf, frosted	12 €	131567191
NOX			
102413010	 WC šepėčio galva Spare WC brushed without handle	5	131567012c
102413010	 WC šepėčio indas atsarginis Glass dish for WC brushed, frosted	9	131567113
102408030	 Muilinė atsarginė matinė Soap dish, frosted	8	131567002m
102410010	 Stiklinė atsarginė matinė Glass cup, frosted	5 €	131567378
102408020	 Dozatorius muilo atsarginis matinis Glass for soap dispenser, frosted	10	131567380
102408020	 Pompa muilo dozatoriui Spare pump complete, chrome	10 €	131567673
PLAZA			
118113092	 WC šepetys su kotu ir dangteliu Spare WC brushed incl. handle with vessel cover	44 €	131567142
118113012	 WC šepetys su kotu ir dangteliu Spare WC brushed incl. handle with vessel cover	34 €	131567198
118113012	 WC šepėčio galva Spare WC brushed without handle	5 €	131567012
118113012	 WC šepėčio galva Spare WC brushed without handle	5 €	131567012c
118113092	 WC šepėčio galva Spare WC brushed without handle	7 €	131567008
118113092	 WC šepėčio galva Spare WC brushed without handle	6 €	131567282
118113012	 WC šepėčio indas atsarginis Glass dish for WC brushed, frosted	17 €	131567041
118108022	 Muilinė atsarginė matinė Soap dish, frosted	15 €	131567039
140108191	 Muilinė atsarginė matinė Soap dish, frosted	15 €	131567146
118110052	 Stiklinė atsarginė matinė Glass cup, frosted	15 €	131567040
118210019 140110061	 Stiklinė atsarginė matinė Glass cup, frosted	14 €	131567199

Prekė Product	Atsarginė dalis Spare part	Kaina Price	Prekės kodas Ordering number
118109042	 Stiklinė atsarginė matinė Glass cup, frosted	42 €	131567035
118109042	 Pompa muilo dozatoriui Spare pump complete, chrome	22 €	131567204
118209049 140109161	 Dozatorius muilo atsarginis matinis Glass for soap dispenser, frosted	27 €	131567044
118209049 140109161	 Pompa muilo dozatoriui Spare pump complete, chrome	30 € 22 €	131567118 131567159
OVAL			
118413011	 WC šepetys su kotu Spare WC brushed with handle	13 €	131567018
118413011	 WC šepetys su kotu Spare WC brushed with handle	13 €	131567018c
118413011	 WC šepėčio galva Spare WC brushed without handle	5 €	131567012
118413011	 WC šepėčio galva Spare WC brushed without handle	5 €	131567012c
118413011	 WC šepėčio indas atsarginis Glass dish for WC brushed, frosted	9 €	131567122
118408021	 Muilinė atsarginė matinė Soap dish, frosted	7 €	131567389
118410011	 Stiklinė atsarginė matinė Glass cup, frosted	8 €	131567001m
118409011	 Dozatorius muilo atsarginis matinis Glass for soap dispenser, frosted	16 €	131567126
118409011	 Pompa muilo dozatoriui Spare pump complete, chrome	30 €	131567118
118402031	 Stiklas lentynėlei atsarginis, matinis Glass for shelf, frosted	10 €	131567121
TASI			
154113012	 WC šepetys su kotu Spare WC brushed with handle	13 €	131567009c
154113012	 WC šepėčio galva Spare WC brushed without handle	7 €	131567008
154113012	 WC šepėčio galva Spare WC brushed without handle	7 €	131567008c
154113012	 WC šepėčio indas atsarginis Glass dish for WC brushed, frosted	9 €	131567003
154108022	 Muilinė atsarginė matinė Soap dish, frosted	8 €	131567002m
154110012	 Stiklinė atsarginė matinė Glass cup, frosted	8 €	131567001m
154109042	 Dozatorius muilo atsarginis matinis Glass for soap dispenser, frosted	35 €	131567243
154109042	 Pompa muilo dozatoriui Spare pump complete, chrome	22 €	131567204
NIKI			
153113012	 WC šepetys su kotu Spare WC brushed with handle	13 €	131567009
153113012	 WC šepetys su kotu Spare WC brushed with handle	13 €	131567009c
153113012	 WC šepėčio galva Spare WC brushed without handle	7 €	131567008
153113012	 WC šepėčio galva Spare WC brushed without handle	7 €	131567008c
153113012	 WC šepėčio indas atsarginis Glass dish for WC brushed, frosted	16 €	131567372

Prekē Product	Atsarginē dalis Spare part	Kaina Price	Prekēs kods Ordering number
153108022	 Muilinē atsarginē matinē Soap dish, frosted	8 €	131567370
153110052	 Stiklinē atsarginē matinē Glass cup, frosted	8 €	131567368
153209049	 Dozatorius muilo atsarginis matinis Glass for soap dispenser, frosted	18 €	131567371
153209049	 Pompa muilo dozatoriui Spare pump complete, chrome	7 €	131567369
153102042	 Stiklas lentynēlei atsarginis, matinis Glass for shelf, frosted	7 €	131567179
KERA			
144713017	 WC šepetys su kotu Spare WC brushed with handle	20 €	131567436
144713017	 WC šepečio galva Spare WC brushed without handle	7 €	131567008
144713017	 WC šepečio indas atsarginis, keramika Glass dish for WC brushed, frosted	9 €	131567095
144708027	 Muilinē atsarginē, keramika Soap dish, ceramics	8 €	131567094
144710017 144710027	 Stiklinē atsarginē, keramika Glass, ceramics	8 €	131567093
144709017	 Dozatorius muilo atsarginis, keramika Glass for soap dispenser, ceramics	12 €	131567068
144709017	 Pompa muilo dozatoriui Spare pump complete, chrome	20 €	131567273
RETRO			
144213018 144313012	 WC šepetys su kotu Spare WC brushed with handle	13 €	131567009
144113017	 WC šepetys su kotu Spare WC brushed with handle	14 €	131567172
144213018 144313012	 WC šepetys su kotu Spare WC brushed with handle	13 €	131567009c
144113017	 WC šepetys su kotu Spare WC brushed with handle	13 €	131567420
144113017 144213018 144313012	 WC šepečio galva Spare WC brushed without handle	7 €	131567008
144113017 144213018 144313012	 WC šepečio galva Spare WC brushed without handle	7 €	131567008c
144113017 144213018 144313012	 WC šepečio indas atsarginis Glass dish for WC brushed, frosted	9 €	131567003
144108027 144208028 144308022	 Muilinē atsarginē matinē Soap dish, frosted	8 €	131567002m
144110017 144110027 144210018 144210028 144310012 144310022	 Stiklinē atsarginē matinē Glass cup, frosted	8 €	131567001m
144109017 144209018 144309012	 Dozatorius muilo atsarginis matinis Glass for soap dispenser, frosted	35 €	131567243
144109107 144209108 144309102	 Dozatorius muilo atsarginis, matinis Glass for soap dispenser, frosted	16 €	131567111
144109017 144109107	 Pompa muilo dozatoriui Spare pump complete, chrome	28 €	131567441

Prekē Product	Atsarginē dalis Spare part	Kaina Price	Prekēs kods Ordering number
144309012 144209018 144309102 144209108	 Pompa muilo dozatoriui Spare pump complete, chrome	22 €	131567442
VISTA			
120113316-XXX	 WC šepečio galva Spare WC brushed without handle	7 €	131567464
120113316-XXX	 WC šepečio galva Spare WC brushed without handle	7 €	131567463
120109016-XXX	 Pompa muilo dozatoriui Spare pump complete, chrome	10 €	131567473
SILIKONAS			
	 WC šepetys su kotu WC brushed with handle	14 €	131567448
TASI 154113012/OMEGA 104113102, 104113012, 104913152, 104913122, 104913112, 104913092, 104113017, 104913152, 104913122, 104913117, 104913092, 104113107/BETA 132113012, 132113017/VIA 135013012/NIKI 153113012/ALFA 102413012/OMEGA 104836012, 132836012			
	 WC šepečio galva Spare WC brushed without handle	10 €	131567447
DARK 102313060, 104113010, KERA 144713017/TASI 154113012, OMEGA 102313066, 104113012, 104913152, 104913122, 104913117, 104913112, 104913092, 104913090, 104113107, 102313057, BETA 132113012, 132113017/RETRO CHROM 144313012, RETRO BRONZ 144113017, RETRO GOLD 144213018, NIKI 153113012/OMEGA 104836012, 132836012			
GUMA			
	 Juodas guminis dangtelis Rubber cover	3 €	131567412
OMEGA 104113102, 104113012, 104913152, 104913122, 104913112, 104913092, RETRO BRONZ 144113018, NEO 104113105, 102313075, 104113015, WHITE 104913094, OVAL 118413011, KERA 144713017			
	 Juodas guminis dangtelis Rubber cover	3 €	131567411
OMEGA 104113107, 104113017, 104913152, 104913122, 104913117, 104913092, NEO 104113109, 104113019, 102313079, CORAL 1581130107, AMBER 155113017, HEMATIT 159113017, GRAPHIT 156113017			



Atsarginis WC šepetys be koto

Spare WC silicone brush without handle
70×100×70 mm
131567447

10 €



Atsarginis WC šepetys su kotu

WC silicone brush with handle
70×355×70 mm

131567448

14 €

HELP

Nerūdijančio plieno rankena, blizgi

Grab bar – stainless steel polished

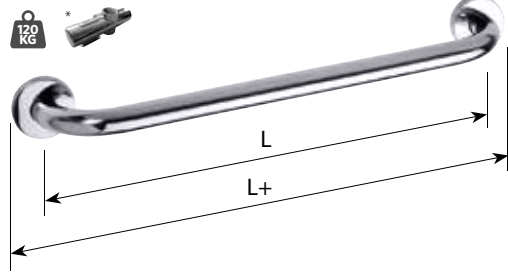

Nerūdijančio plieno rankena, matinė

Grab bar – stainless steel matt



Nerūdijančio plieno rankena, balta

Grab bar – steel powder coated white

Nerūdijančio plieno rankena su tvirtinimo apdaila, balta

Grab bar with cover, steel powder coated white

Nerūdijančio plieno rankena su tvirtinimo apdaila, juoda

Grab bar with cover, steel powder coated black

Rankenos ilgis [L] Product length [L]	Paviršiaus apdaila Finish	Kaina Price	Prekės kodas Ordering number
200 mm	nerūdijantis plienas, blizgus/stainless steel polished	38 €	301100201
	nerūdijantis plienas, matinis/stainless steel matt	41 €	301100202
	baltas/white	25 €	301100204
	baltas su tvirtinimo apdaila/white with cover	37 €	301100203
300 mm	nerūdijantis plienas, blizgus/stainless steel polished	45 €	301100301
	nerūdijantis plienas, matinis/stainless steel matt	54 €	301100302
	baltas/white	26 €	301100304
	baltas su tvirtinimo apdaila/white with cover	42 €	301100303
400 mm	nerūdijantis plienas, blizgus/stainless steel polished	48 €	301100401
	nerūdijantis plienas, matinis/stainless steel matt	55 €	301100402
	baltas/white	28 €	301100404
	baltas su tvirtinimo apdaila/white with cover	47 €	301100403
500 mm	nerūdijantis plienas, blizgus/stainless steel polished	61 €	301100501
	nerūdijantis plienas, matinis/stainless steel matt	65 €	301100502
	baltas/white	31 €	301100504
	baltas su tvirtinimo apdaila/white with cover	47 €	301100503
600 mm	nerūdijantis plienas, blizgus/stainless steel polished	64 €	301100601
	nerūdijantis plienas, matinis/stainless steel matt	63 €	301100602
	baltas/white	37 €	301100604
	baltas su tvirtinimo apdaila/white with cover	47 €	301100603
700 mm	nerūdijantis plienas, blizgus/stainless steel polished	64 €	301100701
	nerūdijantis plienas, matinis/stainless steel matt	70 €	301100702
	baltas/white	39 €	301100704
	baltas su tvirtinimo apdaila/white with cover	53 €	301100703
800 mm	nerūdijantis plienas, blizgus/stainless steel polished	70 €	301100801
	nerūdijantis plienas, matinis/stainless steel matt	71 €	301100802
	baltas/white	46 €	301100804
	baltas su tvirtinimo apdaila/white with cover	59 €	301100803
900 mm	nerūdijantis plienas, blizgus/stainless steel polished	78 €	301100901
	nerūdijantis plienas, matinis/stainless steel matt	84 €	301100902
	baltas/white	49 €	301100904
	baltas su tvirtinimo apdaila/white with cover	54 €	301100903
1000 mm	nerūdijantis plienas, blizgus/stainless steel polished	84 €	301101001
	nerūdijantis plienas, matinis/stainless steel matt	91 €	301101002
	baltas/white	52 €	301101004
	baltas su tvirtinimo apdaila/white with cover	60 €	301101003
1100 mm	nerūdijantis plienas, blizgus/stainless steel polished	87 €	301101101
	nerūdijantis plienas, matinis/stainless steel matt	94 €	301101102
	baltas/white	55 €	301101104
	baltas su tvirtinimo apdaila/white with cover	74 €	301101103
1200 mm	nerūdijantis plienas, blizgus/stainless steel polished	96 €	301101201
	nerūdijantis plienas, matinis/stainless steel matt	99 €	301101202
	baltas/white	61 €	301101204
	baltas su tvirtinimo apdaila/white with cover	77 €	301101203
1500 mm	nerūdijantis plienas, blizgus/stainless steel polished	117 €	301101501
	nerūdijantis plienas, matinis/stainless steel matt	127 €	301101502
	baltas/white	73 €	301101504
	baltas su tvirtinimo apdaila/white with cover	87 €	301101503

U formos porankis stacionarus

Grab bar U-shaped

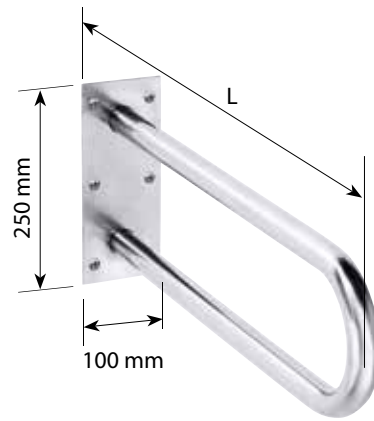

WC popieriaus laikiklis porankiui griebtuvui

Toilet paper holder for grab bar

47×96×150 mm

104112192

24 €

Rankenos ilgis [L] Product length [L]	Paviršiaus apdaila Finish	Kaina Price	Prekės kodas Ordering number
600 mm	nerūdijantis plienas, blizgus/stainless steel polished	88 €	301102051
	nerūdijantis plienas, blizgus, su tvirtinimo apdaila/polished with cover	113 €	301707271
	nerūdijantis plienas, matinis/stainless steel matt	95 €	301102052
	nerūdijantis plienas, matinis, su tvirtinimo apdaila/matt with cover	113 €	301707272
	baltas/white	55 €	301102054
	baltas su tvirtinimo apdaila/white with cover	79 €	301707273
750 mm	nerūdijantis plienas, blizgus/stainless steel polished	94 €	301102301
	nerūdijantis plienas, blizgus, su tvirtinimo apdaila/polished with cover	121 €	301707301
	nerūdijantis plienas, matinis/stainless steel matt	107 €	301102302
	nerūdijantis plienas, matinis, su tvirtinimo apdaila/matt with cover	121 €	301707302
	baltas/white	57 €	301102304
	baltas su tvirtinimo apdaila/white with cover	85 €	301707303
813 mm	nerūdijantis plienas, blizgus/stainless steel polished	125 €	301102061
	nerūdijantis plienas, blizgus, su tvirtinimo apdaila/polished with cover	127 €	301707461
	nerūdijantis plienas, matinis/stainless steel matt	125 €	301102062
	nerūdijantis plienas, matinis, su tvirtinimo apdaila/matt with cover	127 €	301707462
	baltas/white	64 €	301102064
	baltas su tvirtinimo apdaila/white with cover	84 €	301707463
850 mm	nerūdijantis plienas, blizgus/stainless steel polished	131 €	301102041
	nerūdijantis plienas, blizgus, su tvirtinimo apdaila/polished with cover	134 €	301707321
	nerūdijantis plienas, matinis/stainless steel matt	114 €	301102042
	nerūdijantis plienas, matinis, su tvirtinimo apdaila/matt with cover	134 €	301707322
	baltas/white	67 €	301102044
	baltas su tvirtinimo apdaila/white with cover	91 €	301707323
900 mm	nerūdijantis plienas, blizgus/stainless steel polished	114 €	301102991
	nerūdijantis plienas, blizgus, su tvirtinimo apdaila/polished with cover	141 €	301707331
	nerūdijantis plienas, matinis/stainless steel matt	116 €	301102992
	nerūdijantis plienas, matinis, su tvirtinimo apdaila/matt with cover	141 €	301707332
	baltas/white	68 €	301102994
	baltas su tvirtinimo apdaila/white with cover	94 €	301707333

Atrama nugarai

Toilet seat back rest

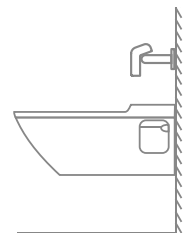
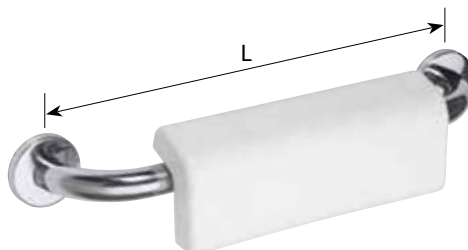

Rankenos ilgis [L] Product length [L]	Paviršiaus apdaila Finish	Kaina Price	Prekės kodas Ordering number
500 mm	nerūdijantis plienas, blizgus, su tvirtinimo apdaila/polished with cover	166 €	301100501-o
	nerūdijantis plienas, matinis, su tvirtinimo apdaila/matt with cover	178 €	301100502-o
	baltas/white	119 €	301100504-o
	baltas su tvirtinimo apdaila/white with cover	129 €	301100503-o

U formos porankis stacionarus su WC popieriaus laikikliu

Grab bar U-shaped with toilet paper holder

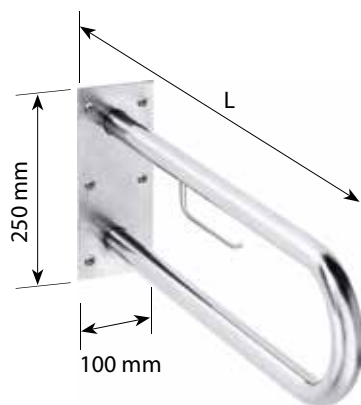

Rankenos ilgis [L] Product length [L]	Paviršiaus apdaila Finish	Kaina Price	Prekės kodas Ordering number
600 mm	nerūdijantis plienas, blizgus/stainless steel polished	100 €	301907271
	nerūdijantis plienas, blizgus, su tvirtinimo apdaila/polished with cover	129 €	301807271
	nerūdijantis plienas, matinis/stainless steel matt	107 €	301907272
	nerūdijantis plienas, matinis, su tvirtinimo apdaila/matt with cover	129 €	301807272
	baltas/white	66 €	301907274
	baltas su tvirtinimo apdaila/white with cover	93 €	301807273
750 mm	nerūdijantis plienas, blizgus/stainless steel polished	113 €	301907301
	nerūdijantis plienas, blizgus, su tvirtinimo apdaila/polished with cover	137 €	301807301
	nerūdijantis plienas, matinis/stainless steel matt	120 €	301907302
	nerūdijantis plienas, matinis, su tvirtinimo apdaila/matt with cover	137 €	301807302
	baltas/white	73 €	301907304
	baltas su tvirtinimo apdaila/white with cover	97 €	301807303
813 mm	nerūdijantis plienas, blizgus/stainless steel polished	113 €	301907461
	nerūdijantis plienas, blizgus, su tvirtinimo apdaila/polished with cover	151 €	301807461
	nerūdijantis plienas, matinis/stainless steel matt	123 €	301907462
	nerūdijantis plienas, matinis, su tvirtinimo apdaila/matt with cover	157 €	301807462
	baltas/white	73 €	301907464
	baltas su tvirtinimo apdaila/white with cover	114 €	301807463
850 mm	nerūdijantis plienas, blizgus/stainless steel polished	124 €	301907321
	nerūdijantis plienas, blizgus, su tvirtinimo apdaila/polished with cover	150 €	301807321
	nerūdijantis plienas, matinis/stainless steel matt	133 €	301907322
	nerūdijantis plienas, matinis, su tvirtinimo apdaila/matt with cover	150 €	301807322
	baltas/white	87 €	301907324
	baltas su tvirtinimo apdaila/white with cover	104 €	301807323
900 mm	nerūdijantis plienas, blizgus/stainless steel polished	124 €	301907331
	nerūdijantis plienas, blizgus, su tvirtinimo apdaila/polished with cover	154 €	301807331
	nerūdijantis plienas, matinis/stainless steel matt	133 €	301907332
	nerūdijantis plienas, matinis, su tvirtinimo apdaila/matt with cover	161 €	301807332
	baltas/white	87 €	301907334
	baltas su tvirtinimo apdaila/white with cover	117 €	301807333

Dušo laikiklis

Shower holder

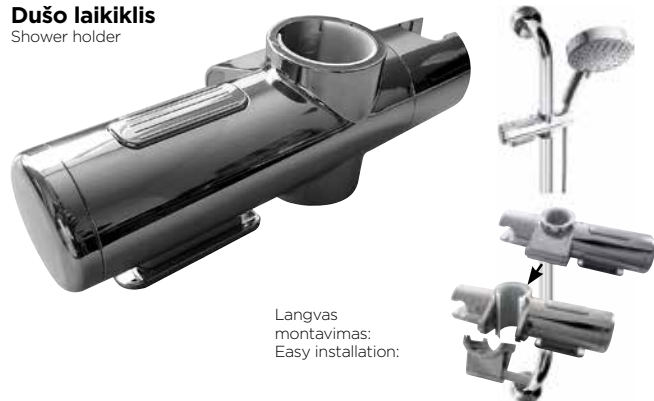

Langvas montavimas:
Easy installation:



Gali būti naudojamas/Can be used for:

Rankena/Grab bar:

500 mm	301100501,2,4,3
600 mm	301100601,2,4,3
700 mm	301100701,2,4,3
800 mm	301100801,2,4,3
900 mm	301100901,2,4,3
1000 mm	301101001,2,4,3
1100 mm	301101101,2,4,3
1200 mm	301101201,2,4,3
1500 mm	301101501,2,4,3

**Rankena/
Shower grab bar:**

890 mm	301122041,2,4,3
	30112041,2,4,3
680 mm	30112061,2,4,3
	30112071,2,4,3

Rankena/Shower grab bar:
301122021,2,4,3
30112021,2,4,3

Paviršiaus apdaila Finish	Kaina Price	Prekės kodas Ordering number
chromuotas plastikas/cromed plastic	56 €	338514372



U formos porankis atlenkiamas
Foldable grab bar U-shaped

1

Rankenos ilgis [L] Product length [L]	Paviršiaus apdaila Finish	Kaina Price	Prekės kodas Ordering number
1 600 mm	nerūdijantis plienas, blizgus/stainless steel polished	138 €	301102071
	nerūdijantis plienas, blizgus, su tvirtinimo apdaila/polished with cover	170 €	301607271
	nerūdijantis plienas, matinis/stainless steel matt	149 €	301102072
	nerūdijantis plienas, matinis, su tvirtinimo apdaila/matt with cover	166 €	301607272
	baltas/white	67 €	301102074
	baltas su tvirtinimo apdaila/white with cover	104 €	301607273
750 mm	nerūdijantis plienas, blizgus/stainless steel polished	149 €	301606301
	nerūdijantis plienas, blizgus, su tvirtinimo apdaila/polished with cover	176 €	301607301
	nerūdijantis plienas, matinis/stainless steel matt	162 €	301606302
	nerūdijantis plienas, matinis, su tvirtinimo apdaila/matt with cover	170 €	301607302
	baltas/white	95 €	301606304
	baltas su tvirtinimo apdaila/white with cover	108 €	301607303
813 mm	nerūdijantis plienas, blizgus/stainless steel polished	150 €	301102081
	nerūdijantis plienas, blizgus, su tvirtinimo apdaila/polished with cover	180 €	301607471
	nerūdijantis plienas, matinis/stainless steel matt	162 €	301102082
	nerūdijantis plienas, matinis, su tvirtinimo apdaila/matt with cover	177 €	301607472
	baltas/white	75 €	301102084
	baltas su tvirtinimo apdaila/white with cover	97 €	301607473
850 mm	nerūdijantis plienas, blizgus/stainless steel polished	164 €	301606321
	nerūdijantis plienas, blizgus, su tvirtinimo apdaila/polished with cover	183 €	301607321
	nerūdijantis plienas, matinis/stainless steel matt	173 €	301606322
	nerūdijantis plienas, matinis, su tvirtinimo apdaila/matt with cover	183 €	301607322
	baltas/white	87 €	301606324
	baltas su tvirtinimo apdaila/white with cover	104 €	301607323
900 mm	nerūdijantis plienas, blizgus/stainless steel polished	157 €	301102901
	nerūdijantis plienas, blizgus, su tvirtinimo apdaila/polished with cover	185 €	301607331
	nerūdijantis plienas, matinis/stainless steel matt	165 €	301102902
	nerūdijantis plienas, matinis, su tvirtinimo apdaila/matt with cover	185 €	301607332
	baltas/white	89 €	301102904
	baltas su tvirtinimo apdaila/white with cover	101 €	301607333
2	aliuminis, chromas/aluminium, chrome	409 €	355107272
3	aliuminis, juodas/aluminium, black	409 €	355107270



U formos porankis atlenkiamas su WC popieriaus laikikliu

Foldable grab bar U-shaped with toilet paper holder

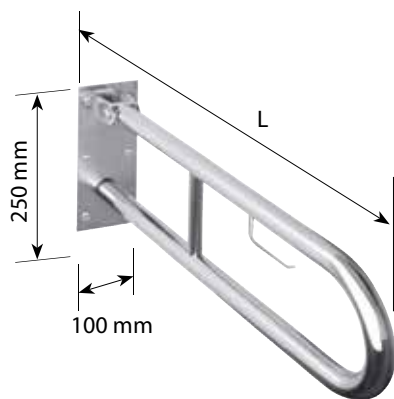

U formos porankis atlenkiamas, tvirtinamas prie grindų

Foldable grab bar, ground mounted

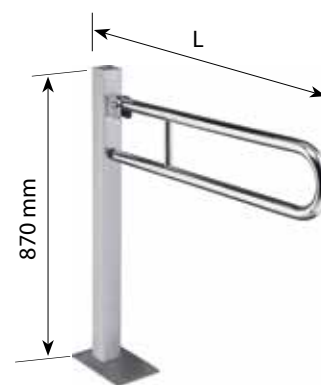

Rankenos ilgis [L] Product length [L]	Paviršiaus apdaila Finish	Kaina Price	Prekės kodas Ordering number	
1 600 mm	nerūdijantis plienas, blizgus/stainless steel polished	161 €	301102271	
	nerūdijantis plienas, blizgus, su tvirtinimo apdaila/polished with cover	179 €	301407271	
	nerūdijantis plienas, matinis/stainless steel matt	171 €	301406272	
	nerūdijantis plienas, matinis, su tvirtinimo apdaila/matt with cover	186 €	301407272	
	baltas/white	95 €	301406274	
	baltas su tvirtinimo apdaila/white with cover	106 €	301407273	
	750 mm	nerūdijantis plienas, blizgus/stainless steel polished	164 €	301406301
		nerūdijantis plienas, blizgus, su tvirtinimo apdaila/polished with cover	186 €	301407301
		nerūdijantis plienas, matinis/stainless steel matt	175 €	301406302
		nerūdijantis plienas, matinis, su tvirtinimo apdaila/matt with cover	193 €	301407302
		baltas/white	96 €	301406304
		baltas su tvirtinimo apdaila/white with cover	113 €	301407303
813 mm	nerūdijantis plienas, blizgus/stainless steel polished	165 €	301102281	
	nerūdijantis plienas, blizgus, su tvirtinimo apdaila/polished with cover	193 €	301407281	
	nerūdijantis plienas, matinis/stainless steel matt	177 €	301102282	
	nerūdijantis plienas, matinis, su tvirtinimo apdaila/matt with cover	199 €	301407282	
	baltas/white	97 €	301102284	
	baltas su tvirtinimo apdaila/white with cover	119 €	301407283	
850 mm	nerūdijantis plienas, blizgus/stainless steel polished	172 €	301406321	
	nerūdijantis plienas, blizgus, su tvirtinimo apdaila/polished with cover	199 €	301407321	
	nerūdijantis plienas, matinis/stainless steel matt	169 €	301406322	
	nerūdijantis plienas, matinis, su tvirtinimo apdaila/matt with cover	206 €	301407322	
	baltas/white	106 €	301406324	
	baltas su tvirtinimo apdaila/white with cover	126 €	301407323	
900 mm	nerūdijantis plienas, blizgus/stainless steel polished	173 €	301102291	
	nerūdijantis plienas, blizgus, su tvirtinimo apdaila/polished with cover	199 €	301407291	
	nerūdijantis plienas, matinis/stainless steel matt	183 €	301102292	
	nerūdijantis plienas, matinis, su tvirtinimo apdaila/matt with cover	206 €	301407292	
	baltas/white	96 €	301102294	
	baltas su tvirtinimo apdaila/white with cover	111 €	301407293	
2 750 mm	nerūdijantis plienas, blizgus/stainless steel polished	284 €	301107301	
	nerūdijantis plienas, blizgus, su tvirtinimo apdaila/polished with cover	317 €	301507301	
	nerūdijantis plienas, matinis/stainless steel matt	307 €	301107302	
	nerūdijantis plienas, matinis, su tvirtinimo apdaila/matt with cover	324 €	301507302	
	baltas/white	190 €	301107304	
	baltas su tvirtinimo apdaila/white with cover	231 €	301507303	
813 mm	nerūdijantis plienas, blizgus/stainless steel polished	290 €	301107601	
	nerūdijantis plienas, blizgus, su tvirtinimo apdaila/polished with cover	324 €	301507601	
	nerūdijantis plienas, matinis/stainless steel matt	313 €	301107602	
	nerūdijantis plienas, matinis, su tvirtinimo apdaila/matt with cover	331 €	301507602	
	baltas/white	197 €	301107604	
	baltas su tvirtinimo apdaila/white with cover	237 €	301507603	
850 mm	nerūdijantis plienas, blizgus/stainless steel polished	297 €	301107321	
	nerūdijantis plienas, blizgus, su tvirtinimo apdaila/polished with cover	324 €	301507321	
	nerūdijantis plienas, matinis/stainless steel matt	320 €	301107322	
	nerūdijantis plienas, matinis, su tvirtinimo apdaila/matt with cover	331 €	301507322	
	baltas/white	204 €	301107324	
	baltas su tvirtinimo apdaila/white with cover	237 €	301507323	

Nuimamas U formos porankis atlenkiamas

Removable folded grab

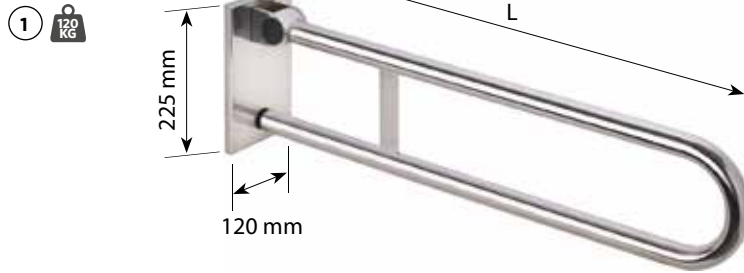

Tvirtinimo plokštė

The anchor plate

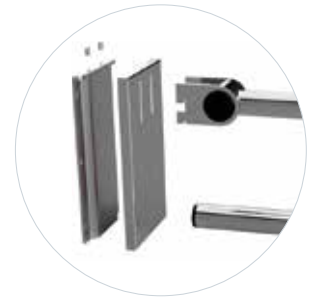
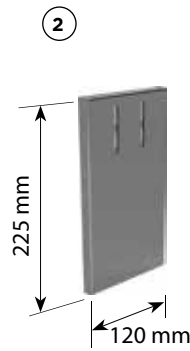

Rankenos ilgis [L] Product length [L]	Paviršiaus apdaila Finish	Kaina Price	Prekės kodas Ordering number
① 600 mm	nerūdijantis plienas, blizgus, su tvirtinimo apdaila/polished with cover	161 €	301507821
	nerūdijantis plienas, matinis, su tvirtinimo apdaila/matt with cover	156 €	301507825
800 mm	nerūdijantis plienas, blizgus, su tvirtinimo apdaila/polished with cover	182 €	301507831
	nerūdijantis plienas, matinis, su tvirtinimo apdaila/matt with cover	174 €	301507835

Griebtuvui: For grab bar:	Paviršiaus apdaila Finish	Kaina Price	Prekės kodas Ordering number
② 301507821, 301507831	nerūdijantis plienas, blizgus, su tvirtinimo apdaila/polished with cover	19 €	301507841
301507825, 301507835	nerūdijantis plienas, matinis, su tvirtinimo apdaila/matt with cover	19 €	301507845

U formos porankis atlenkiamas su užraktu

Folding grab bar with locking

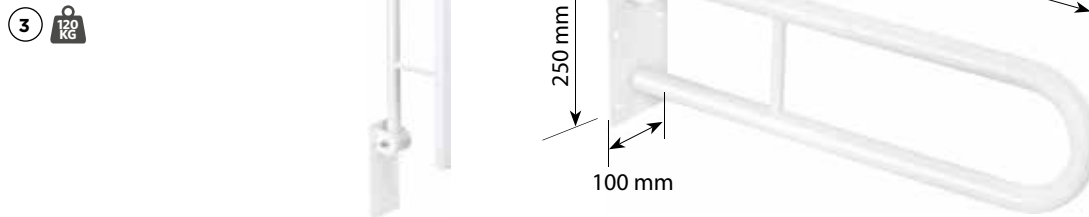

Rankenos ilgis [L] Product length [L]	Paviršiaus apdaila Finish	Kaina Price	Prekės kodas Ordering number
③ 600 mm	baltas/white	69 €	301507804
800 mm	baltas/white	72 €	301507814

Rankena, tvirtinama ant durų

Door handle



Rankenos ilgis [L] Product length [L]	Paviršiaus apdaila Finish	Kaina Price	Prekės kodas Ordering number
④ 700 mm	nerūdijantis plienas, matinis/stainless steel matt	61 €	301553015
	baltas/white	56 €	301553014
	juodas/black	56 €	301553010
800 mm	nerūdijantis plienas, matinis/stainless steel matt	65 €	301553025
	baltas/white	58 €	301553024
	juodas/black	58 €	301553020

**U formos porankis
atlenkiamas su atrama
į grindis**

Foldable bar U-shaped

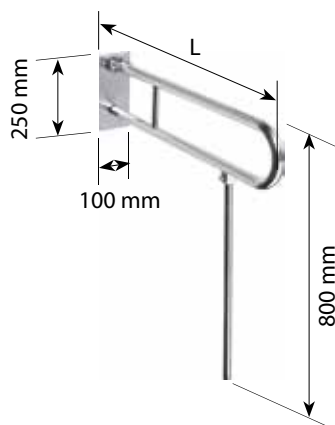

**U formos porankis atlenkiamas
su atrama į grindis
su WC popieriaus laikikliu**

Foldable grab bar U-shaped with supporting
leg with toilet paper holder



Rankenos ilgis [L] Product length [L]	Paviršiaus apdaila Finish	Kaina Price	Prekės kodas Ordering number	
1 600 mm	nerūdijantis plienas, blizgus/stainless steel polished	161 €	301102071N	
	nerūdijantis plienas, blizgus, su tvirtinimo apdaila/polished with cover	197 €	301307071N	
	nerūdijantis plienas, matinis/stainless steel matt	173 €	301102072N	
	nerūdijantis plienas, matinis, su tvirtinimo apdaila/matt with cover	198 €	301307072N	
	baltas/white	90 €	301102074N	
	baltas su tvirtinimo apdaila/white with cover	115 €	301307073N	
	750 mm	nerūdijantis plienas, blizgus/stainless steel polished	161 €	301606301N
		nerūdijantis plienas, blizgus, su tvirtinimo apdaila/polished with cover	193 €	301307301N
		nerūdijantis plienas, matinis/stainless steel matt	174 €	301606302N
		nerūdijantis plienas, matinis, su tvirtinimo apdaila/matt with cover	200 €	301307302N
		baltas/white	94 €	301606304N
		baltas su tvirtinimo apdaila/white with cover	115 €	301307303N
813 mm	nerūdijantis plienas, blizgus/stainless steel polished	175 €	301102081N	
	nerūdijantis plienas, blizgus, su tvirtinimo apdaila/polished with cover	199 €	301307081N	
	nerūdijantis plienas, matinis/stainless steel matt	182 €	301102082N	
	nerūdijantis plienas, matinis, su tvirtinimo apdaila/matt with cover	199 €	301307082N	
	baltas/white	125 €	301102084N	
	baltas su tvirtinimo apdaila/white with cover	150 €	301307083N	
850 mm	nerūdijantis plienas, blizgus/stainless steel polished	178 €	301606321N	
	nerūdijantis plienas, blizgus, su tvirtinimo apdaila/polished with cover	206 €	301307321N	
	nerūdijantis plienas, matinis/stainless steel matt	185 €	301606322N	
	nerūdijantis plienas, matinis, su tvirtinimo apdaila/matt with cover	209 €	301307322N	
	baltas/white	106 €	301606324N	
	baltas su tvirtinimo apdaila/white with cover	129 €	301307323N	
2 600 mm	nerūdijantis plienas, blizgus/stainless steel polished	174 €	301102271N	
	nerūdijantis plienas, blizgus, su tvirtinimo apdaila/polished with cover	209 €	301407271N	
	nerūdijantis plienas, matinis/stainless steel matt	191 €	301406272N	
	nerūdijantis plienas, matinis, su tvirtinimo apdaila/matt with cover	217 €	301407272N	
	baltas/white	109 €	301406274N	
	baltas su tvirtinimo apdaila/white with cover	146 €	301407273N	
	750 mm	nerūdijantis plienas, blizgus/stainless steel polished	179 €	301406301N
		nerūdijantis plienas, blizgus, su tvirtinimo apdaila/polished with cover	213 €	301407301N
		nerūdijantis plienas, matinis/stainless steel matt	191 €	301406302N
		nerūdijantis plienas, matinis, su tvirtinimo apdaila/matt with cover	219 €	301407302N
		baltas/white	113 €	301406304N
		baltas su tvirtinimo apdaila/white with cover	138 €	301407303N
813 mm	nerūdijantis plienas, blizgus/stainless steel polished	178 €	301102281N	
	nerūdijantis plienas, blizgus, su tvirtinimo apdaila/polished with cover	222 €	301407281N	
	nerūdijantis plienas, matinis/stainless steel matt	190 €	301102282N	
	nerūdijantis plienas, matinis, su tvirtinimo apdaila/matt with cover	233 €	301407282N	
	baltas/white	111 €	301102284N	
	baltas su tvirtinimo apdaila/white with cover	153 €	301407283N	
850 mm	nerūdijantis plienas, blizgus/stainless steel polished	191 €	301406321N	
	nerūdijantis plienas, blizgus, su tvirtinimo apdaila/polished with cover	224 €	301407321N	
	nerūdijantis plienas, matinis/stainless steel matt	193 €	301406322N	
	nerūdijantis plienas, matinis, su tvirtinimo apdaila/matt with cover	233 €	301407322N	
	baltas/white	117 €	301406324N	
	baltas su tvirtinimo apdaila/white with cover	153 €	301407323N	

Porankis atlenkiamas

Foldable grab bar

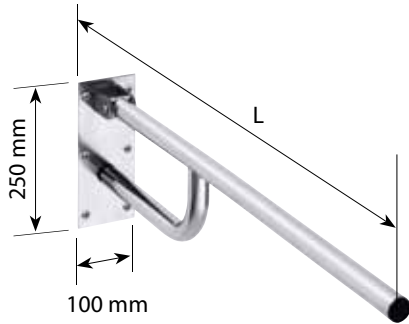
**Porankis atlenkiamas su WC popieriaus laikikliu**

Foldable grab bar with toilet paper holder



Rankenos ilgis [L] Product length [L]	Paviršiaus apdaila Finish	Kaina Price	Prekės kodas Ordering number
① 760 mm	nerūdijantis plienas, blizgus/stainless steel polished	140 €	301102091
	nerūdijantis plienas, blizgus, su tvirtinimo apdaila/polished with cover	167 €	301607091
	nerūdijantis plienas, matinis/stainless steel matt	140 €	301102092
	nerūdijantis plienas, matinis, su tvirtinimo apdaila/matt with cover	174 €	301607092
	baltas/white	78 €	301102094
	baltas su tvirtinimo apdaila/white with cover	104 €	301607093
850 mm	nerūdijantis plienas, blizgus/stainless steel polished	155 €	301102321
	nerūdijantis plienas, blizgus, su tvirtinimo apdaila/polished with cover	171 €	301607161
	nerūdijantis plienas, matinis/stainless steel matt	164 €	301102322
	nerūdijantis plienas, matinis, su tvirtinimo apdaila/matt with cover	176 €	301607162
	baltas/white	83 €	301102324
	baltas su tvirtinimo apdaila/white with cover	109 €	301607163
② 760 mm	nerūdijantis plienas, blizgus/stainless steel polished	153 €	301102771
	nerūdijantis plienas, blizgus, su tvirtinimo apdaila/polished with cover	186 €	301607771
	nerūdijantis plienas, matinis/stainless steel matt	163 €	301102772
	nerūdijantis plienas, matinis, su tvirtinimo apdaila/matt with cover	193 €	301607772
	baltas/white	91 €	301102774
	baltas su tvirtinimo apdaila/white with cover	123 €	301607773
850 mm	nerūdijantis plienas, blizgus/stainless steel polished	171 €	301102781
	nerūdijantis plienas, blizgus, su tvirtinimo apdaila/polished with cover	190 €	301607781
	nerūdijantis plienas, matinis/stainless steel matt	183 €	301102782
	nerūdijantis plienas, matinis, su tvirtinimo apdaila/matt with cover	195 €	301607782
	baltas/white	89 €	301102784
	baltas su tvirtinimo apdaila/white with cover	128 €	301607783

Rankena kampu 120°

Angled grab bar 120°

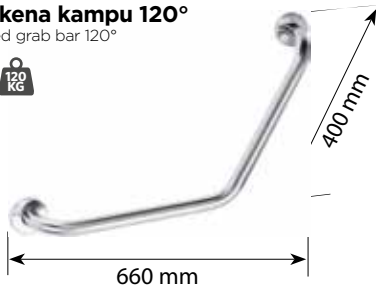
**Dušo porankis**

Shower grab bar

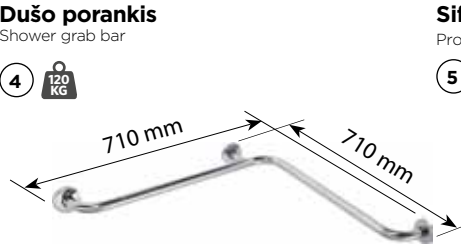
**Sifono apsauga**

Protection of dip-pipe against wheelchair crash



③ 660×400 mm	nerūdijantis plienas, blizgus, su tvirtinimo apdaila/polished with cover	85 €	301102011
	nerūdijantis plienas, matinis, su tvirtinimo apdaila/matt with cover	83 €	301102012
	baltas/white	64 €	301102014
	baltas su tvirtinimo apdaila/white with cover	67 €	301102013
④ 710×710 mm	nerūdijantis plienas, blizgus, su tvirtinimo apdaila/polished with cover	134 €	301102031
	nerūdijantis plienas, matinis, su tvirtinimo apdaila/matt with cover	139 €	301102032
	baltas/white	65 €	301102034
	baltas su tvirtinimo apdaila/white with cover	86 €	301102033
⑤ 545×266 mm	nerūdijantis plienas, blizgus, su tvirtinimo apdaila/polished with cover	70 €	301102121
	nerūdijantis plienas, matinis, su tvirtinimo apdaila/matt with cover	76 €	301102122
	baltas/white	40 €	301102124
	baltas su tvirtinimo apdaila/white with cover	59 €	301102123

Dušo porankis

Shower grab bar with smooth vertical buttress

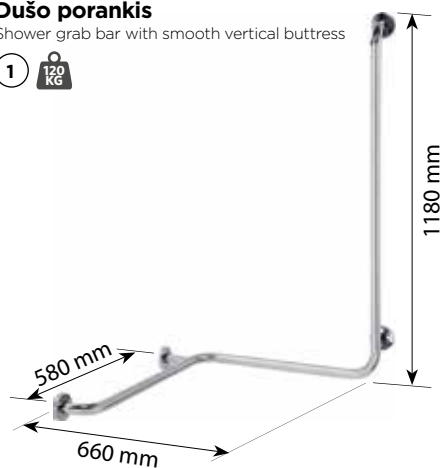

Porankis prie WC

Grab bar

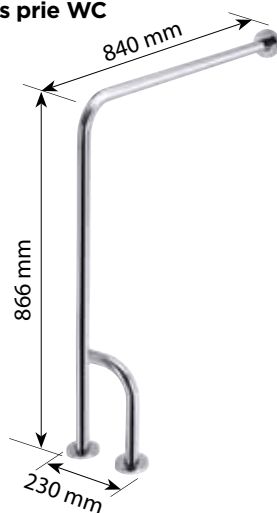

Dušo porankis

Shower grab bar

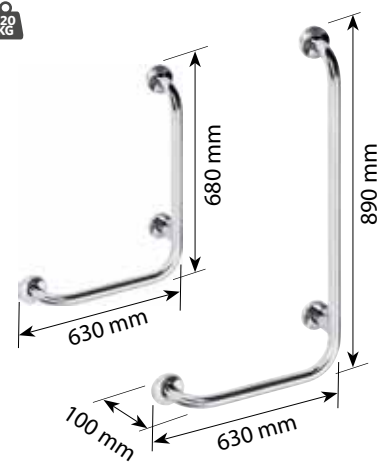

Rankenos ilgis [L] Product length [L]	Paviršiaus apdaila Finish	Kaina Price	Prekės kodas Ordering number
1			
dešinė/right	nerūdijantis plienas, blizgus, su tvirtinimo apdaila/polished with cover	182 €	301122021
	nerūdijantis plienas, matinis, su tvirtinimo apdaila/matt with cover	188 €	301122022
	baltas/white	121 €	301122024
	baltas su tvirtinimo apdaila/white with cover	131 €	301122023
kairė/left	nerūdijantis plienas, blizgus, su tvirtinimo apdaila/polished with cover	182 €	301112021
	nerūdijantis plienas, matinis, su tvirtinimo apdaila/matt with cover	188 €	301112022
	baltas/white	121 €	301112024
	baltas su tvirtinimo apdaila/white with cover	131 €	301112023
	juodas su tvirtinimo apdaila/black with cover	131 €	301112020
2			
dešinė/right	nerūdijantis plienas, blizgus, su tvirtinimo apdaila/polished with cover	187 €	301122141
	nerūdijantis plienas, matinis, su tvirtinimo apdaila/matt with cover	195 €	301122142
	baltas/white	90 €	301122144
	baltas su tvirtinimo apdaila/white with cover	115 €	301122143
kairė/left	nerūdijantis plienas, blizgus, su tvirtinimo apdaila/polished with cover	187 €	301112131
	nerūdijantis plienas, matinis, su tvirtinimo apdaila/matt with cover	202 €	301112132
	baltas/white	92 €	301112134
	baltas su tvirtinimo apdaila/white with cover	115 €	301112133
3			
dešinė/right	nerūdijantis plienas, blizgus, su tvirtinimo apdaila/polished with cover	135 €	301122041
890 mm	nerūdijantis plienas, matinis, su tvirtinimo apdaila/matt with cover	139 €	301122042
	baltas/white	88 €	301122044
	baltas su tvirtinimo apdaila/white with cover	110 €	301122043
kairė/left	nerūdijantis plienas, blizgus, su tvirtinimo apdaila/polished with cover	133 €	301112041
890 mm	nerūdijantis plienas, matinis, su tvirtinimo apdaila/matt with cover	138 €	301112042
	baltas/white	88 €	301112044
	baltas su tvirtinimo apdaila/white with cover	110 €	301112043
dešinė/right	nerūdijantis plienas, blizgus, su tvirtinimo apdaila/polished with cover	129 €	301112061
680 mm	nerūdijantis plienas, matinis, su tvirtinimo apdaila/matt with cover	138 €	301112062
	baltas/white	87 €	301112064
	baltas su tvirtinimo apdaila/white with cover	106 €	301112063
kairė/left	nerūdijantis plienas, blizgus, su tvirtinimo apdaila/polished with cover	129 €	301112071
680 mm	nerūdijantis plienas, matinis, su tvirtinimo apdaila/matt with cover	139 €	301112072
	baltas/white	87 €	301112074
	baltas su tvirtinimo apdaila/white with cover	106 €	301112073

Dušo porankis sulankstomas

Foldable shower grab bar with smooth vertical buttress

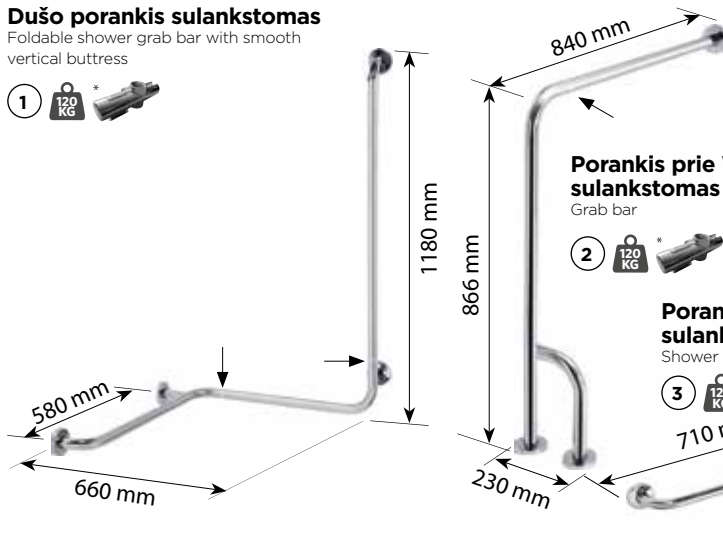
**Porankis prie WC, sulankstomas**

Grab bar

**Porankis prie WC, sulankstomas**

Shower grab bar

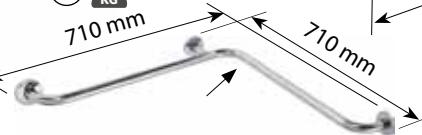
**Porankis prie WC, sulankstomas**

Shower grab bar

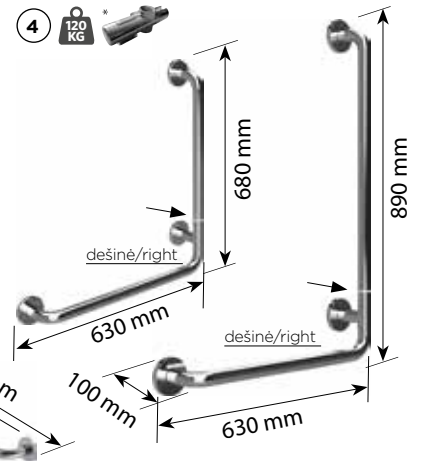

Rankenos ilgis [L] Product length [L]	Paviršiaus apdaila Finish	Kaina Price	Prekės kodas Ordering number
1	dešinė/right	nerūdijantis plienas, blizgus, su tvirtinimo apdaila/polished with cover	182 € 301153021
		nerūdijantis plienas, matinis, su tvirtinimo apdaila/matt with cover	188 € 301153022
		baltas/white	131 € 301153023
		baltas su tvirtinimo apdaila/white with cover	121 € 301153024
	kairė/left	nerūdijantis plienas, blizgus, su tvirtinimo apdaila/polished with cover	182 € 301154021
		nerūdijantis plienas, matinis, su tvirtinimo apdaila/matt with cover	188 € 301154022
		baltas/white	131 € 301154023
		baltas su tvirtinimo apdaila/white with cover	121 € 301154024
2	dešinė/right	nerūdijantis plienas, blizgus, su tvirtinimo apdaila/polished with cover	187 € 301153141
		nerūdijantis plienas, matinis, su tvirtinimo apdaila/matt with cover	195 € 301153142
		baltas/white	115 € 301153143
		baltas su tvirtinimo apdaila/white with cover	90 € 301153144
	kairė/left	nerūdijantis plienas, blizgus, su tvirtinimo apdaila/polished with cover	187 € 301154131
		nerūdijantis plienas, matinis, su tvirtinimo apdaila/matt with cover	202 € 301154132
		baltas/white	115 € 301154133
		baltas su tvirtinimo apdaila/white with cover	92 € 301154134
3	710×710 mm	nerūdijantis plienas, blizgus, su tvirtinimo apdaila/polished with cover	134 € 301153031
		nerūdijantis plienas, matinis, su tvirtinimo apdaila/matt with cover	139 € 301153032
		baltas/white	86 € 301153033
		baltas su tvirtinimo apdaila/white with cover	65 € 301153034
4	dešinė/right	nerūdijantis plienas, blizgus, su tvirtinimo apdaila/polished with cover	129 € 301153061
	680 mm	nerūdijantis plienas, matinis, su tvirtinimo apdaila/matt with cover	138 € 301153062
		baltas/white	106 € 301153063
		baltas su tvirtinimo apdaila/white with cover	87 € 301153064
	kairė/left	nerūdijantis plienas, blizgus, su tvirtinimo apdaila/polished with cover	129 € 301154071
		680 mm	nerūdijantis plienas, matinis, su tvirtinimo apdaila/matt with cover
		baltas/white	106 € 301154073
		baltas su tvirtinimo apdaila/white with cover	87 € 301154074
	dešinė/right	nerūdijantis plienas, blizgus, su tvirtinimo apdaila/polished with cover	135 € 301153041
		890 mm	nerūdijantis plienas, matinis, su tvirtinimo apdaila/matt with cover
			baltas/white
		baltas su tvirtinimo apdaila/white with cover	88 € 301153044
kairė/left	nerūdijantis plienas, blizgus, su tvirtinimo apdaila/polished with cover	133 € 301154041	
	890 mm	nerūdijantis plienas, matinis, su tvirtinimo apdaila/matt with cover	138 € 301154042
		baltas/white	110 € 301154043
	baltas su tvirtinimo apdaila/white with cover	88 € 301154044	

Porankis

Grab bar

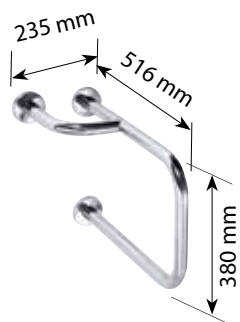

Porankis

Compound grab bar to sink

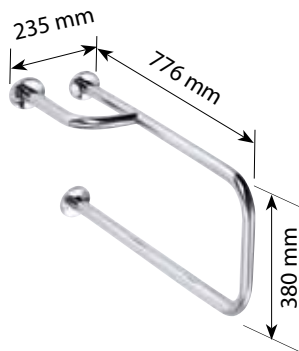

Rankena su lentynėle

Compound grab bar to sink



Rankenos ilgis [L] Product length [L]	Paviršiaus apdaila Finish	Kaina Price	Prekės kodas Ordering number
1 dešinė/right	nerūdijantis plienas, blizgus, su tvirtinimo apdaila/polished with cover	141 €	301122111
500 mm	nerūdijantis plienas, matinis, su tvirtinimo apdaila/matt with cover	152 €	301122112
	baltas/white	76 €	301122114
	baltas su tvirtinimo apdaila/white with cover	102 €	301122113
kairė/left	nerūdijantis plienas, blizgus, su tvirtinimo apdaila/polished with cover	141 €	301112101
500 mm	nerūdijantis plienas, matinis, su tvirtinimo apdaila/matt with cover	152 €	301112102
	baltas/white	76 €	301112104
	baltas su tvirtinimo apdaila/white with cover	102 €	301112103
2 dešinė/right	nerūdijantis plienas, blizgus, su tvirtinimo apdaila/polished with cover	166 €	301112161
760 mm	nerūdijantis plienas, matinis, su tvirtinimo apdaila/matt with cover	178 €	301112162
	baltas/white	91 €	301112164
	baltas su tvirtinimo apdaila/white with cover	113 €	301112163
kairė/left	nerūdijantis plienas, blizgus, su tvirtinimo apdaila/polished with cover	166 €	301112151
760 mm	nerūdijantis plienas, matinis, su tvirtinimo apdaila/matt with cover	178 €	301112152
	baltas/white	91 €	301112154
	baltas su tvirtinimo apdaila/white with cover	113 €	301112153
3 580×220 mm	nerūdijantis plienas, blizgus, su tvirtinimo apdaila/polished with cover	114 €	301100571
	nerūdijantis plienas, matinis, su tvirtinimo apdaila/matt with cover	122 €	301100572
	baltas/white	69 €	301100574
	baltas su tvirtinimo apdaila/white with cover	75 €	301100573



Vonios kambario aksesuarai - saugiam judėjimui vonios kambaryje.
Aksesuarai pagaminti iš nerūdijančio plieno. Gali būti blizgūs, matinisiniai ir balti. Platus formų ir dydžių pasirinkimas. Visi Prekėai yra aukštos kokybės ir sertifikuoti.

Bathroom accessories for safe movement in your bathroom.
Finish: stainless steel polished, stainless steel matt, steel powder coated white. Wide variability of shapes and dimensions. High product quality demonstrated by certificates.

Dangtelis

Back cover for mounting on door

1

**Atlenkiama dušo kėdutė**

Reversible shower seat

2

150 KG

**Atlenkiama dušo kėdutė**

Reversible shower seat

3

180 KG

**Dušo kėdutės 347125011 tvirtinimas gipso kartono sienai**

Construction for fixing in plasterboard shower seat 347125011

4



1	Paviršiaus apdaila Finish	Kaina Price	Prekės kodas Ordering number
	nerūdijantis plienas, blizgus/stainless steel polished	19 €	131567174
	nerūdijantis plienas, matinis/stainless steel matt	19 €	131567175
	baltas/white	19 €	131567176
2	aliuminis, plast/aluminium, plastic	320 €	355125037
3	Nerūdijantis plienas, plastikas/stainless steel, plastic	286 €	347125011
	juodas, plastikas/black, plastic	289 €	347125010
4	plienas/steel	115 €	347625051

Atlenkiama dušo kėdutė su atrama

Reversible shower seat with buttress stand

5

160 KG

**Atlenkiama dušo kėdutė su atrama**

Reversible shower seat with buttress stand

6

**Atlenkiama dušo kėdutė**

Reversible shower seat

7



	Paviršiaus apdaila Finish	Kaina Price	Prekės kodas Ordering number
5	aliuminis, plastmasinis/aluminium, plastic	120 €	353125033
6	nerūdijantis plienas, blizgus/stainless steel polished	225 €	301102181
	nerūdijantis plienas, blizgus, su tvirtinimo apdaila/polished with cover	247 €	301207181
	nerūdijantis plienas, matinis/stainless steel matt	237 €	301102182
	nerūdijantis plienas, matinis, su tvirtinimo apdaila/matt with cover	260 €	301207182
	baltas/white	268 €	301102184
	baltas su tvirtinimo apdaila/white with cover	283 €	301207183
7	plastikas, nerūdijantis plienas/Kunststoff, Edelstahl/нержавејка, пластик	138 €	326325056

Vonios kėdutė

Removable and adjustable bathtub seat



Dušo kėdutė, pakabinama ant porankio

Shower seat, hanging on the handle



Dušo kėdutė

Shower chair



Dušo kėdutė

Shower chair



Dušo kėdutė su porankiais

Shower chair with armrests



Dušo kėdutė su atlošu

Shower chair with backrest



Dušo kėdutė su atlošu ir porankiais

Shower chair with backrest and armrests



Paviršiaus apdaila Finish	Kaina Price	Prekės kodas Ordering number
1 Nerūdijantis plienas, plastikas/stainless steel, plastic	175 €	338125066
2 Nerūdijantis plienas, plastikas/stainless steel, plastic	233 €	338125081
3 Nerūdijantis plienas, plastikas/stainless steel, plastic	238 €	338125071
4 aliuminis, plastmasinis/aluminium, plastic	85 €	353125043
5 aliuminis, plastmasinis/aluminium, plastic	120 €	353125103
6 aliuminis, plastmasinis/aluminium, plastic	120 €	353125123
7 aliuminis, plastmasinis/aluminium, plastic	134 €	353125113

Atlenkiama dušo kėdutė

Folding shower seat



Atlenkiama dušo kėdutė

Folding shower seat



Atlošas su porankiais

Backrest with armrests



Atlošas

Backrest



10 ir 11 gali būti komplektuojamas 8 su 9
10 and 11 can be combined with 8 and 9



Uždanga guminė kėdutei

Seat cover



Paviršiaus apdaila Finish	Kaina Price	Prekės kodas Ordering number
8 Nerūdijantis plienas, plastikas/stainless steel, plastic	547 €	355125137
9 Nerūdijantis plienas, plastikas/stainless steel, plastic	647 €	355125147
10 Nerūdijantis plienas, plastikas/stainless steel, plastic	476 €	355125167
11 aliuminis, plastmasinis/aluminium, plastic	200 €	355125157
12 guminė/rubber	115 €	355125170

PASTABOS
NOTE

A series of horizontal dotted lines for writing notes.

Bemeta katalogas

Catalogues Bemeta



Peržiūrėkite katalogą su visu mūsų pasiūlymu adresu www.bemeta.com

Check out the catalog with our complete offer at www.bemeta.com

**Teisės keisti produkcijos asortimentą, kainas, dizainą ir informaciją saugomos.
Informacija ir paveikslėliai atitinka katalogo paskelbimo laikotarpį.**

Changes in products, prices, design and informations reserved.

Informations and images are corresponding to the time of the catalog publication. Errors and misprints excepted.

LT - 6/2024

BEMETA

BEMETA DESIGN s. r. o.

Žatčany 28
664 53 Česká republika

Tel.: +420 544 224 338
GSM: +420 739 201 806

■ www.bemeta.com
■ info@bemeta.cz